

# Design for Success!

ZILOG REFERENCE DESIGN and APPLICATION

# COOKBOOK



Accelerate your Designs and Time to Market!  
[www.zilog.com](http://www.zilog.com)

# Introducing ZNEO32!

## Zilog's Line of 32-bit Cortex-M3 based Programmable Motor Controllers

ZNEO32! uses high performance 32-bit computing, 3-phase PWM generators, and high speed ADC units to provide an effective, low-cost system solution for motor applications.

Part Number	Core	Flash	SRAM	Max. Freq.	ADC		TIMERS	UART	SPI	I2C	MPWM	ADC	I/O Ports	Pkg.
					Resolution	Speed								
Z32F06410AES	Cortex-M3	64KB	8KB	48MHz	12-bit x 2-unit	1.5MS/s	6-16bit	2	1	1	1	2-unit 11 ch	44	48 LQFP
Z32F06410AKS	Cortex-M3	64KB	8KB	48MHz	12-bit x 2-unit	1.5MS/s	6-16bit	2	1	1	1	2-unit 8 ch	28	32 LQFP
Z32F12811ARS	Cortex-M3	128KB	12KB	72MHz	12-bit x 3-unit	1.5MS/s	6-16bit	2	2	2	2	3-unit 16 ch	48	64 LQFP
Z32F12811ATS	Cortex-M3	128KB	12KB	72MHz	12-bit x 3-unit	1.5MS/s	6-16bit	4	2	2	2	3-unit 16 ch	64	80 LQFP
Z32F38412ALS	Cortex-M3	384KB	16KB	72MHz	12-bit x 2-unit	1.5MS/s	10-16bit + FRT	4	2	2	2	2-unit 16 ch	86	100 LQFP
Z32F38412ATS	Cortex-M3	384KB	16KB	72MHz	12-bit x 2-unit	1.5MS/s	10-16bit + FRT	4	2	2	2	2-unit 16 ch	64	80 LQFP

### Key Features:

- High Performance Low-power Cortex-M3 Core
- 64KB, 128KB, or 384KB Code Flash
- Memory with Cache function
- 8KB, 12KB, or 24KB SRAM
- 3-Phase PWM with ADC triggering function (1-2 Channels)
- 1.5MSPS high-speed ADC with sequential conversion function
- Watchdog Timer
- External communication ports
- Six General Purpose Timers
- Industrial grade operating temperature (-40 ~ +85°C)

ZNEO32! Evaluation Kits	
Z32F0640100KITG	ZNEO32! 64K Evaluation Kit
Z32F1280100KITG	ZNEO32! 128K Evaluation Kit

### Z32F06410AxS Block Diagram

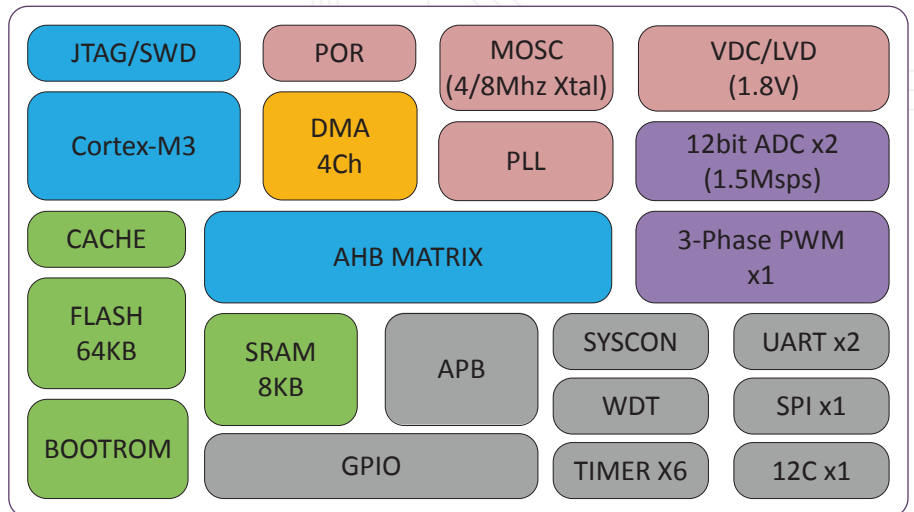

### Typical Applications:

- BLDC/PMSM Motors
- Outdoor Air Conditioners
- Washing Machines
- Refrigerators



For more information about the ZNEO32! Series, Evaluation Kits, or to download product collateral and software, please visit [www.zilog.com](http://www.zilog.com).



## Table of Contents

---

Reference Designs	1 - 23
Educational Platform and Kit	24
Battery Charging Solutions	25 - 26
BDC Motor Control with Z8 Encore!	27 - 28
BLDC Motor Control with Z8 Encore!	29 - 30
AC Induction & Brushless DC Motor Control	31 - 32
ZMOTION Detection and Control	33 - 34
ZMOTION Occupancy Detection	35 - 36
ZMOTION 8-Pin Occupancy Detection	37 - 38
ZMOTION 20-Pin Occupancy Detection	39 - 40
ZMOTION Intrusion Detection	41 - 42
Ethernet Connectivity Solutions	43
Multi Protocol Serial Communications	44
Low Voltage & Low Power Solutions	45





## DMX Reference Design Kit Reference Design

The DMX Reference Design Kit includes a Z8051-based DMX512-A Receiver reference design built with Zilog's Z51F0811 MCU and a DMX512-A controller using Zilog's Z51F3220 MCU. The receiver primarily functions as a light controller and, alternately, as a sound generator. As a lighting device, the receiver obtains data from the DMX controller that manages the display of four high-bright LEDs using the Z51F0811 MCU's PWM function. As a sound generator, the receiver activates a speaker that is connected to the Z51F0811 MCU's buzzer driver. The UART peripheral of the Z51F0811 MCU is used to connect the DMX512-A receiver to the DMX512-A controller.

### Features

#### Receiver

- Configurable DMX base slot address via six-position DIP switch
- Optically-isolated DMX512-A interface
- Four high-brightness LEDs
- Buzzer for generating sound output
- Ability to manipulate NULL start code (0) and alternate start code (207)

#### Controller

- Three modes of operation
  - Local Mode – allows control via five on-board potentiometers (1 pot per DMX slot; base address is hard coded in the firmware)
  - PC Mode – allows control via a PC application
  - Demo mode – allows pre-stored sequences to be generated.

### Associated Documentation

RD0015	A DMX512-A Receiver Using a Z51F0811 MCU
RD0015-SC01	Source code for the DMX512-A Receiver Using a Z51F0811 MCU
RD0016	Implement a DMX512-A Controller Using the Z51F3220 MCU
RD0016-SC01	Source Code for Implement a DMX512-A Controller Using the Z51F3220 MCU

### Related Documentation

PS0296	Z51F0811 Product Specification
PS0299	Z51F3220 Product Specification
PUG0033	Z8051 Tools Product User Guide
UM0242	Z51F0811 Evaluation Kit User Manual
UM0243	Z51F3220 Development Kit User Manual

The DMX512-A Receiver design is based on the 28-pin Z51F0811 microcontroller, which manages all functions related to the operation of this receiver. The Receiver design takes advantage of the specific peripherals of the MCU. The Z51F0811 microcontroller features four PWM channels for the LEDs, a buzzer driver for the buzzer/speaker, and a UART device for the DMX controller. The 8 MHz internal oscillator is used as a system clock. The unused GPIOs are used to address the Receiver. The Receiver hardware is fabricated on a single circuit board and made as small as possible. This reference design can either be powered externally via a wall-mounted power supply ranging from 7 V–12 V or through a USB serial interface. A selector switch is implemented to allow for selection of the power source.

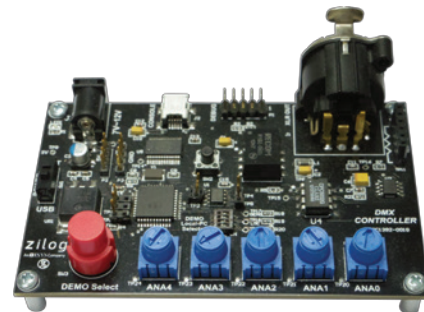

All DMX512-A controller functions are implemented using a single circuit board. An external wall mount with a 7–12 V power supply is used to supply power to the Board. Alternatively, a USB serial interface can also be used to supply power to the Board.

### Kit Contents

The DMX Reference Design Kit can be ordered from the Zilog Store. It ships with the following items:

- Configurable DMX base slot address via six-position DIP switch
- DMX Controller Power Board
- DMX Receiver Power Board
- Z8051 USB OCD II Kit
- USB A-Male to MiniB-Male cable
- 5-pin XLR cable (Male-Female)
- 9V wall power adapter





## EVO Reference Design Board Reference Design

Zilog's EVO reference design is a microcontroller board based on the ZNEO Z16F2810 MCU. It includes 14 digital input/output pins, 6 analog pins, a 20 MHz crystal oscillator, a USB connection, a power jack, an ICSP header, and a reset button. The expandability provided by this board offers unlimited potential for new application development. Zilog's EVO Board is fully compatible with the Arduino platform.

The EVO Board can be connected to a computer with a USB cable or powered by a 9 V power source. The power source is selected automatically. External (non-USB) power is obtained either from an AC-to-DC adapter or a battery. The adapter is connected by plugging a 2.1 mm center-positive plug into the board's power jack. Leads from a battery can be inserted in the Gnd and Vin pin headers of the POWER connector. The board can operate on an external supply of 6 V to 20 V; the recommended range is 6 V-12 V.

The maximum length and width of the EVO PCB are 2.7 and 2.1 inches respectively. Four screw holes allow the board to be attached to a surface or case.

This reference design can be programmed in C language using Zilog's ZNEO ZDSII IDE or EVO IDE (under development).

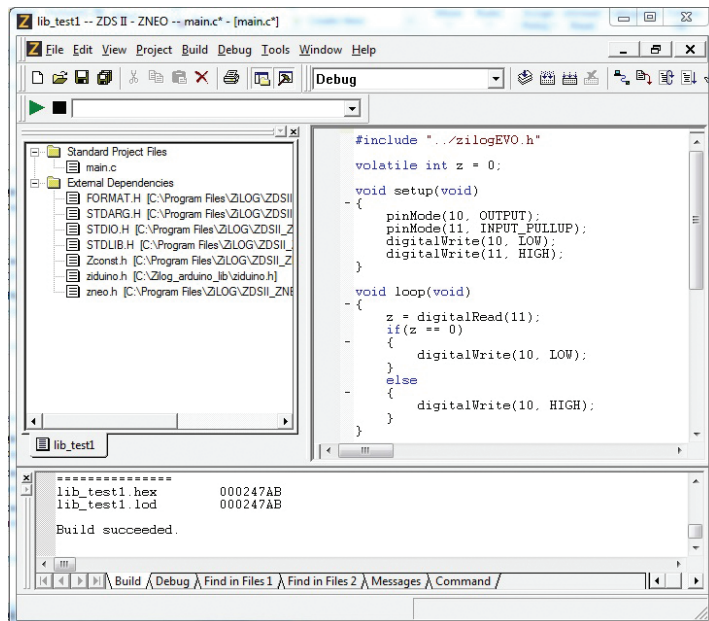
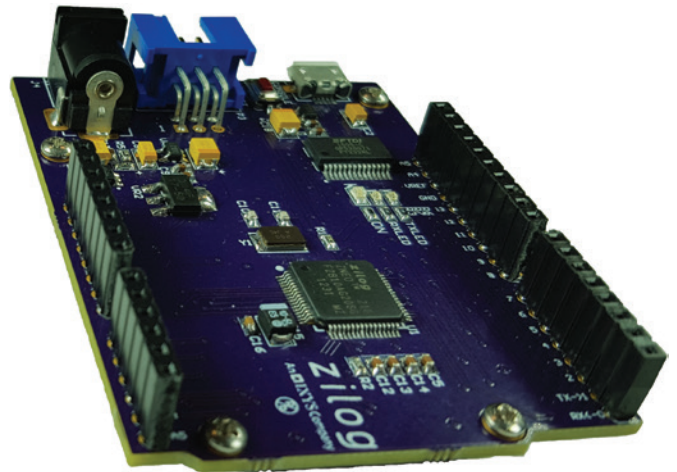
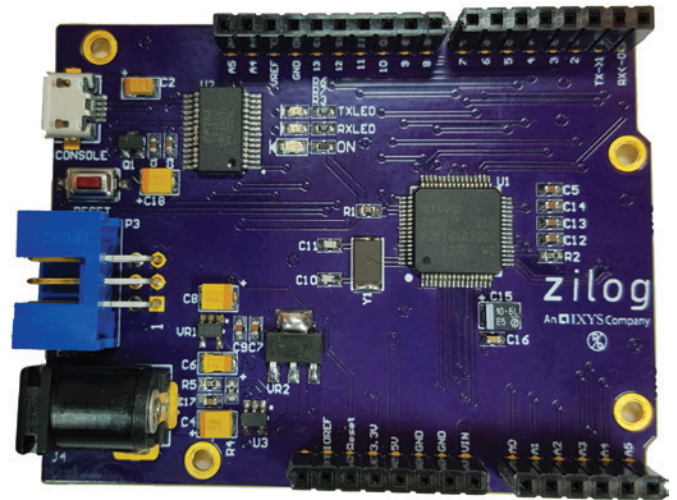

### Features

- ZNEO MCU with 128 K internal Flash and 4 K RAM memory with 16-bit access
- 24-bit address bus supports 16 MB external memory
- Application Shield Peripheral Interface with stackable feature; compatible with any shield available for the Arduino UNO board
- Multiple main power options:
  - 6 V-12 V wall adapter
  - 9 V battery
  - Micro USB
- 14 digital I/O
- 6 analog input (also configurable to be digital I/O)
- 3.3 V, 5 V, and 9 V power output
- Reset button

### Applications

- LED driver/control
- Motor driver/control
- Wireless communication (RF, WIFI, Bluetooth, and IR) (with Shield only)
- Sensor applications

## High Power Two-Phase Digital Power Factor Correction Reference Design

This High Power Two-Phase Digital Power Factor Correction reference design builds upon IXYS Corporation's Digital Power Control technology and extends it to high power levels in the area of Power Factor Correction (PFC). It introduces fast switching, high current, high voltage X2-class MOSFETs and incorporates Digital Inrush Current Control concepts. Functional control is based upon Zilog's 8-bit Z8F6481 microcontroller, a member of the Z8 Encore! XP F6482 Series of MCUs.

### Features

- Conversion power, maximum: 1.06 kW @120V power line
- Input Voltage: 105 -140 V AC 50/60 Hz
- Output Voltage: 400 V  $\pm$  2%, programmable
- Output Current: 2.65A @400V
- Output Voltage Ripples: <6% at full load
- Input Current Ripples: <2%
- Load Variation Range: >8x
- Device Conversion Frequency : 100-120 kHz at high power
- Programmable Overload, Overvoltage, and Brownout Protection
- Digital Inrush Current Control
- Soft Start mode
- Power Good status

### Applications

This reference design provides a platform for developing a variety of power management applications using AC-DC converters with IXYS power devices and an MCU, including the following applications:

- Medical equipment
- Battery charging
- Air conditioning systems
- High power LED lighting
- Welding equipment

### Associated Documentation

- |               |   |
|---------------|---|
| IXRD1004      | High Power Two-Phase Digital Power Factor Correction Reference Design                     |
| IXRD1004-SC01 | Source Code for the High Power Two-Phase Digital Power Factor Correction Reference Design |

### Related Documentation

- |               |   |
|---------------|---|
| IXRD1001      | Digital Inrush Current Controller Reference Design                                |
| IXRD1001-SC01 | Source Code for the Digital Inrush Current Controller Reference Design            |
| IXRD1002      | High Power Digital Inrush Current Controller Reference Design                     |
| IXRD1002-SC01 | Source Code for the High Power Digital Inrush Current Controller Reference Design |

### Kit Contents

The High Power Two-Phase Digital Power Factor Correction Reference Design Kit contains the following items:

- High Power Two-Phase Digital PFC Reference Design device
- Opto-isolated USB SmartCable
- High Power Two-Phase Digital PFC Reference Design Kit Insert

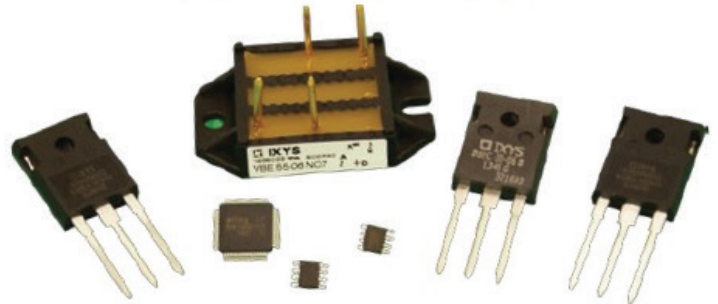
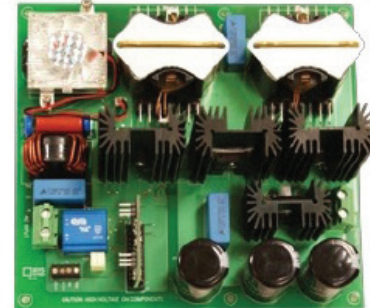
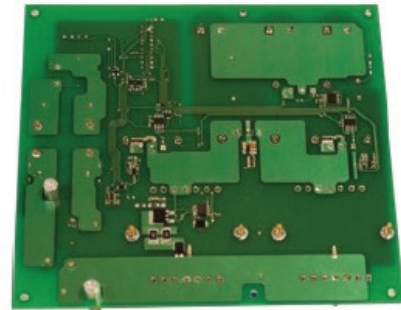

## Digital Inrush Current Controller Reference Design

The Digital Inrush Current Controller reference design combines IXYS' Digital Power Control technology with the capabilities of Zilog's 8-bit Z8F3281 microcontroller, a member of the Z8 Encore! XP F6482 Series of MCUs, to demonstrate a unique approach to controlling inrush current in AC–DC rectifiers or AC–DC converters.

### Features

- Input voltage range from 80 V to 240 V RMS
- Wide input frequency range – 50/60/400Hz
- Steady load current up to 3 A
- Programmable overload protection
- Power Good status signal
- High endurance
- Voltage ripples 15% at 2.5 A load and output capacitance of 720  $\mu$ F
- Option to expand bulk capacitor value using external capacitors
- Inrush current limited to predefined value
- Option to turn Load ON/OFF

This reference design is well suited for high power loads with tens of amperes of current in Normal Mode of operation. It allows users to optimize performance, maximize efficiency across the load range, and reduce the design time to market. IXYS power components handle the pre-charge of load capacitors at these values while limiting inrush current to controlled values.

The firmware that controls the operations of this Digital Inrush Current Controller reference design was developed using Zilog's Development Studio II (ZDS II – Z8 Encore! version 5.2.0). The following hardware components were used during the development of this reference design:

- USB SmartCable – provides communication with ZDS II – Z8 Encore! version 5.2.0, debugging, and downloading code into the F3281 MCU
- Connector J5 2x3, straight male header

### Associated Documentation

IXRD1001 Digital Inrush Current Controller Reference Design  
IXRD1001-SC01 Source Code for the Digital Inrush Current Controller Reference Design

### Related Documentation

PS0294 F6482 Series General-Purpose Flash Microcontroller Product Specification  
UM0263 F6482 Series Development Kit User Manual  
RM0064 F6482 Series API Programmer's Reference Manual

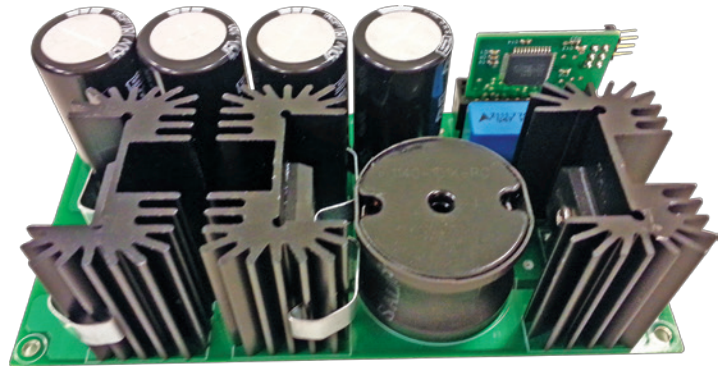

The Digital Inrush Current Controller reference design provides a basis for developing a variety of power management applications using Zilog's MCU with IXYS power devices, including the following applications:

- High Power AC– DC Rectifier
- High Power AC– DC PFC Converter

This device includes the following components:

- Typical power components of an AC–DC rectifier (diode bridge, inductor, and bulk capacitor)
- Switch Sw1 to commutate capacitor pre-charging current
- Switch Sw2 to connect/disconnect load
- Digital control module based on Zilog's Z8F3281 MCU

This reference design can be configured for different parameters such as input voltage and frequency range, overload threshold, overload recovery time, number of overload events before shutdown, time position for Power Good status, and time position to turn ON the Load.

### Kit Contents

- Digital Inrush Controller Reference Design Block
- Opto-isolated USB SmartCable
- Digital Inrush Controller Reference Design Kit Insert





## High Power Digital Inrush Current Controller Reference Design

The High Power Digital Inrush Current Controller reference design extends IXYS' Digital Power Control technology to high current levels and introduces high current MOSFETs with current mirror sensors. High power digital inrush current control is based on Zilog's 8-bit Z8F3281 microcontroller, a member of the Z8 Encore! XP F6482 Series of MCUs, and IXYS power transistors and rectifiers.

### Features

- Input voltage range from 80 V to 240 V RMS
- Steady load current up to 10 A
- Programmable overload protection
- Power Good status signal High endurance
- Not sensitive to power outage or brownout
- Not sensitive to ambient temperature variations
- Voltage ripples 12% at 10 A load current and output capacitance of 3000  $\mu$ F

The Digital Inrush Current Controller reference design provides a basis for developing a variety of power management applications using Zilog's MCU with IXYS power devices, including the following applications:

- High Power AC– DC Rectifier
- High Power AC– DC PFC Converter

The IXYS High Power Digital Inrush Current Controller consists of an MCU Module and a Main Power Board. The MCU Module is implemented as an add-on device. This module comprises of a connector for MCU programming. The MCU Module is powered by an auxiliary power supply (+3.3 V for the MCU and 12 V for the gate driver applied to the connector J4 on the Main Power Board).

Controller reference design was developed using Zilog's Development Studio II (ZDS II – Z8 Encore! version 5.2.0). The following hardware components were used during the development of this reference design:

- USB SmartCable – provides communication with ZDS II – Z8 Encore! version 5.2.0, debugging, and downloading code into the F3281 MCU
- Connector J5 2x3, straight male header

### Associated Documentation

IXRD1002	High Power Digital Inrush Current Controller Reference Design
IXRD1002-SC01	Source Code for the High Power Digital Inrush Current Controller Reference Design

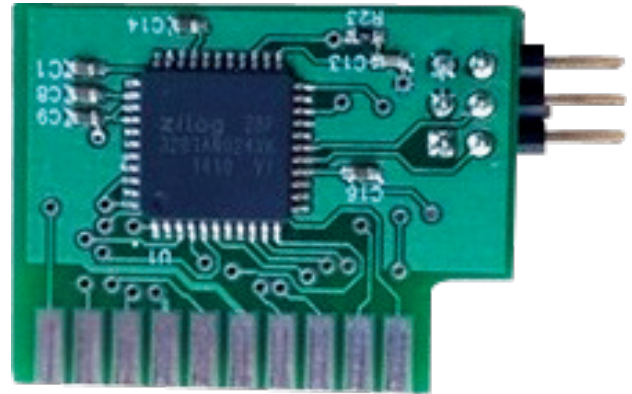

This reference design can be configured for different parameters such as input voltage and frequency range, overload threshold, overload recovery time, number of overload events before shutdown, and time position for Power Good status.

### Related Documentation

IXRD1001	Digital Inrush Current Controller Reference Design
IXRD1001-SC01	Source Code for the Digital Inrush Current Controller Reference Design
PS0294	F6482 Series General-Purpose Flash Microcontroller Product Specification
UM0263	F6482 Series Development Kit User Manual
RM0064	F6482 Series API Programmer's Reference Manual

### Kit Contents

- Digital Inrush Current Controller Reference Design Block
- Opto-isolated USB SmartCable
- Digital Inrush Current Controller Reference Design Kit Insert



Embedded in Life

An IXYS Company



## LED Flashlight Controller Reference Design

The Z8 Encore! XP-based LED Flashlight Controller reference design employs the PWM block of Zilog's Z8F082A MCU to control the power and functional modes of an LED flashlight. The addition of an MCU to power and manage the LED provides opportunities for control of custom lighting patterns and sequencing, user interface control, and increased efficacy (in lumens per Watt) to result in longer battery life at greater lumen output. Additionally, an MCU implementation enables an application developer to modify or add functionality via a simple program update versus a hardware redesign.

### Associated Documentation

RD0032	LED Flashlight Driver Controller Reference Design document
RD0032-SC01	Source Code for the LED Flashlight Controller/Driver Using a Z8 Encore! XP MCU Reference Design

### Related Documentation

PS0228	Z8 Encore! XP F082A Series Product Specification
UM0181	USB SmartCable User Manual
PB0136	Z8 Encore! XP F082A Series Product Brief
UM0186	Z8 Encore! XP F082A Series Development Kit User Manual

### Features

- Z8F082A MCU with six I/O pins and 8 KB Flash
- In-system driver programming using a modified Zilog USB SmartCable
- Fast reprogramming from a hex or batch file to create a library of groups and modes
- 8x AMC7135 stackable pads (2800 mA)
- Open source for sharing and potential application improvement
- Low voltage detect is supported by the MCU (not implemented in the initial release)
- MCU temperature sensor is supported (not implemented in the initial release)
- Zilog Developer Studio IDE with C Compiler
- 17 mm diameter driver
- 4.5 KHz PWM
- 3 groups, multiple modes, and memory at ON time
- Low material cost

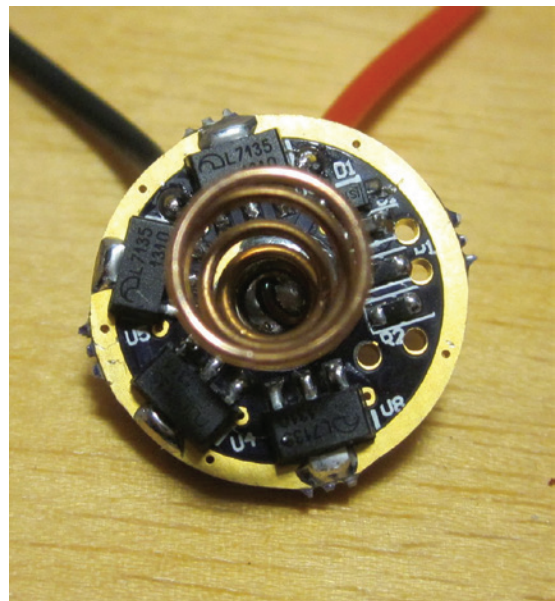
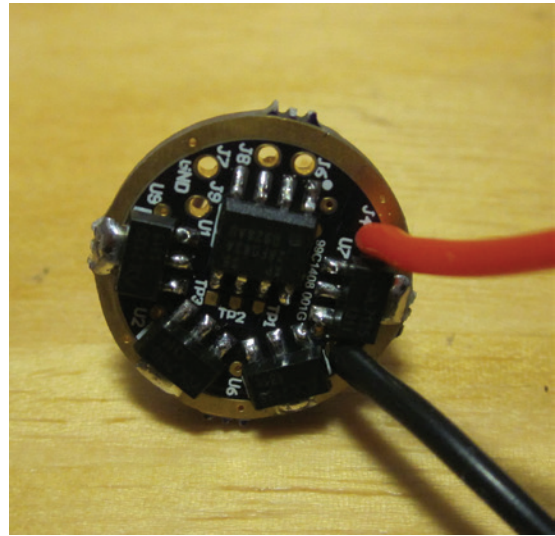

The LED Flashlight Controller reference design consists of a single printed circuit board (PCB) featuring Zilog's Z8F082A MCU in an 8-pin SOIC package, plus resistors, AMC7135 current regulators, a diode, and a capacitor. The PCB is powered by a Lithium-ion battery (3.7 V to 4.2 V) through a battery spring and PCB ground ring. The PCB features four plated through-holes that provide easy access for in-system programming through the spring side of the driver. The 17 mm-diameter dimension of the PCB is suitable for most flashlights available in the market.

After battery voltage is applied to the PCB, the MCU reads the contents of Z8F082A Flash memory for group and mode data that was saved in a previous operation. If there is no valid code (i.e., this is the first time you are using the MCU), it will default to Group 1 and Low Mode.

The LED Flashlight Driver Controller is shipped with the code preprogrammed and ready to use. This reference design does not include a USB SmartCable, which is available separately in the Zilog Store.





Embedded in Life

An IXYS Company



## Z8F2480 Power Monitor with eZ80F91 Webserver Reference Design

This reference design integrates a Z8F2480-based AC power monitor with Zilog’s eZ80F91 Webserver Module to showcase the capability of an optically-isolated Z8F2480 MCU-based power monitor to measure AC input voltage, AC load current, voltage/current phase shift, the power factor of the load, and to communicate via a standard Ethernet interface and webserver. The Z8F2480 MCU and the eZ80F91 Webserver Module are connected for easy mounting. The load is powered via a single-phase AC line with voltage in the range of 90 V to 240 V RMS at 50 Hz or 60 Hz. The Z8F2480 MCU-based power board provides current to a power load and provides optically-isolated I2C signals to communicate with the eZ80F91 Module. This reference design can be used as a basis for developing systems that can control different power installations, including motors and lighting ballasts.

### Features

- 90 –240 V AC RMS input voltage range
- Load current up to 3 amps
- Less than 5 mA average current consumed from an AC line in either monitoring or standby modes
- 3750 V isolation voltage between the AC line and the eZ80F91 MCU

### Applications

- Remote-operated commercial or architectural lighting monitors
- Remote-operated AC motors or other devices

This Z8F2480 Power Monitor/eZ80F91 Webserver reference design consists of a base power board with an eZ80F91Module affixed to it. The Module is located on the bottom of the board. This base Power Board is a two-layer surface-mount platform that provides easy probe access points to all AC inputs and outputs, thereby allowing the user to quickly connect and measure electrical characteristics and waveforms. The Power Board is powered from the same single-phase AC line with a 90-240 V voltage range to which a load is connected; it is able to provide up to 3 A current to the load. The dimensions of the Power Board are 3.1" (L) x 2.9" (W) x 0.7" (H) without the eZ80F91 Webserver Module attached.

### Associated Documentation

RD0027	Z8F2480 Power Monitor with eZ80F91 Webserver Reference Design
RD0027-SC01	Source Code for the Z8F2480 Power Monitor with eZ80F91 Webserver Reference Design

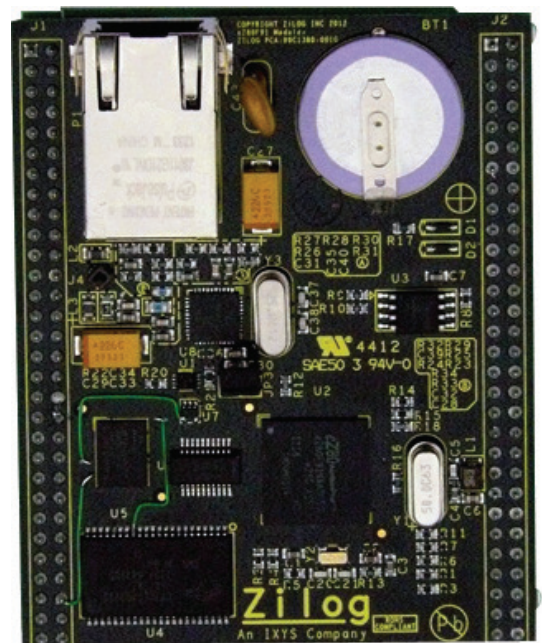
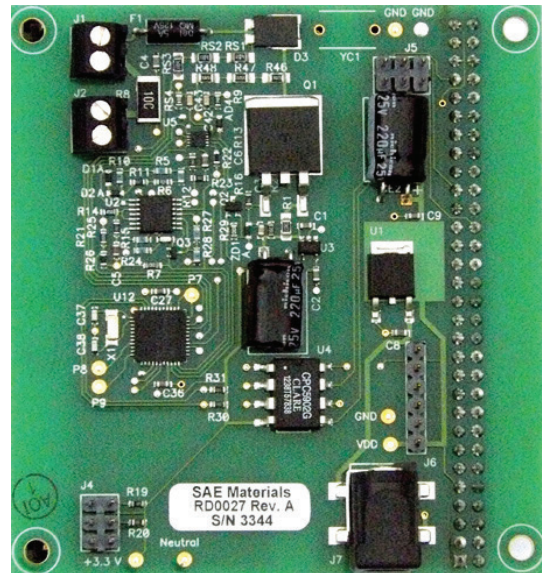

### Related Documentation

PS0306	eZ80Acclaim!/eZ80AcclaimPlus! Ethernet Module Product Specification
PS0250	Z8 Encore! XP F1680 Product Specification
PS0270	eZ80F91 ASSP Product Specification

### Kit Contents

The Z8F2480 Power Monitor with eZ80F91 Webserver Reference Design Kit contains the items listed below. You can order it from the Zilog Store.

- Z8F2480 AC Monitor Power Board
- eZ80F91 Webserver Module
- 5 VDC power supply
- UART-to-RS232 adapter
- Z8F2480 Power Monitor with eZ80F91 Webserver Kit Insert (FL0164)





Embedded in Life

An IXYS Company



## RFID Reader/Programmer Reference Design

The RFID Reader/Programmer reference design provides the ability to read and program Radio Frequency Identification (RFID) transponders, also known as tags. This reference design focuses on RFID Transponders NCD1015 and NCD1025 from IXYS San Sebastian, though it is well suited to add other transponders.

This reference design uses the 134.2 K frequency band, supporting ISO 11784/85 standards. The ISO 11784 standard specifies the structure of the identification code, while the ISO 11785 standard specifies the transmission protocols from the transponder to the reader. The transponders use the Half duplex protocol from the ISO 11785 standard.

Communication from the transponder to the reader is done with FSK modulation, using NRZ encoding, per the ISO specification. The communication from the reader to the transponder is done with an ASK modulation, using a Pulse Interval encoding. The tags are read/writable with the ability to lock.

### Associated Documentation

RD0040	RFID Reader/Programmer Reference Design
RD0040-SC01	Source Code for the RFID Reader/Programmer Reference Design

### Related Documentation

PS0294	F6482 Series General-Purpose Flash Microcontroller Product Specification
UM0263	F6482 Series Development Kit User Manual

### Features

- Battery operated for in-field work or powered from the wall for more extensive operations.
- Ability to program RFID transponders
- Ability to read RFID transponders, including sub-pages
- Easy-to-use buttons to control reading, with LCD display for information on the RFID transponder.
- Ability to interface with the PC for additional control and automation capabilities
- 1 MB EEPROM storage to keep track of different transponders' ID and information



### Applications

- Inventory management
- Temperature verification for medical supplies, wines, and other temperature-sensitive products
- Pet tracking/identification
- Tradeshow visitor tracking
- Security badge tracking/entry/exit

This reference design utilizes many features of Zilog's Z8F6482 MCU, including a comparator, the DAC (used as a reference to the comparator), Real Time Clock (RTC), ADC, and low power. A 3-volt coin cell is used to provide power to the microcontroller in Stop Mode and to keep the RTC running. When a button is pressed, or the USB cable is plugged in, the system wakes up and turns on the main power driven from the 9V battery/power supply, which drives the circuitry without being on the 3-volt coin cell.



## Buck Converter Battery Charger Reference Design

This Buck Converter Battery Charger reference design employs Zilog's Z8F042A MCU to control a step-down DC-DC converter (also known as a buck converter) that acts as a regulated power source. The buck converter battery charger hardware is capable of regulating charger output in a number of modes, such as constant voltage, constant current or constant voltage with a current limit.

The charger can be viewed as a complete control system. The type and capacity of the battery determines the mode of operation of the battery controller – namely, a constant current source or a constant voltage source. The voltage (VSET) and current (ISET) set-points are also determined by the type and capacity of the battery. All battery control loop operations can be controlled by the user via the Z8F042A MCU's UART block, and feedback is provided in the Hyper-Terminal console. Additionally, LEDs provide a visual status of the charging process.

### Buck Converter

In general, a buck converter consists of an inductor, two switches, a transistor and a diode to control the inductor. The PWM alternates between connecting the inductor to a source of voltage to store energy in the inductor, and discharging the inductor into the load.

In this reference design, the PWM is an input to the buck converter, which is controlled by the MCU at an 80 kHz variable-PWM duty cycle. Depending on the charging speed, the output of the converter usually ranges from 1V to 4V; this voltage is supplied to the battery. Both the feedback charge current and charge voltage are controlled by the PI loop.

Download the latest version of ZDS II for Z8 Encore! from the 'Downloadable Software' category in the Zilog Store.

### Associated Documentation

Buck Converter Battery Charger Using the Z8F042A MCU Reference Design (RD0013)  
Source code for the Buck Converter Battery Charger Using the Z8F042A MCU Reference Design (RD0013-SC01)

### Related Documentation

Z8 Encore! XP F082A Series Product Brief (PB0136)  
Z8 Encore! XP F082A Series Product Specification (PS0228)  
Z8 Encore! XP F082A Series Development Kit User Manual (UM0186)

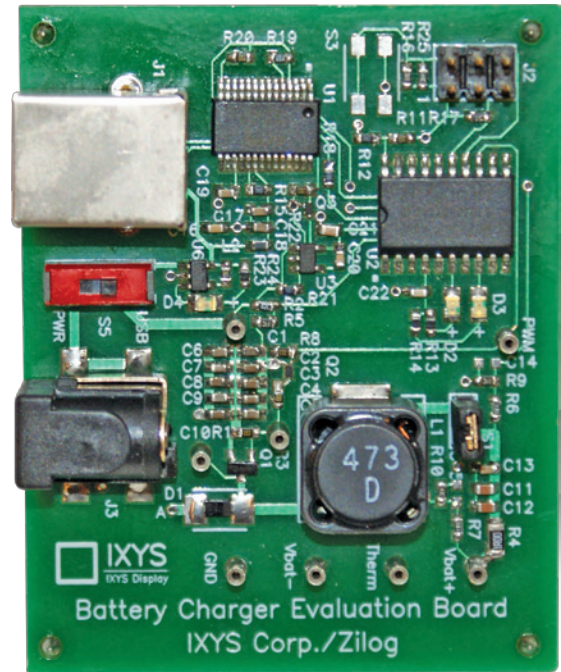

## Buck Converter Battery Charger Features

- Z8F042A MCU featuring a highly accurate Sigma-Delta ADC
- Buck converter with proportional/integral controlled constant current and voltage
- Differential ADC for current measurements
- Complete programmability
- Current/voltage control independent of user input
- UART-controlled operation
- In-circuit programming for upgrading or modifying firmware

The source code file associated with this reference design, RD0013-SC01.zip, is available free for download from the Zilog website. This source code has been tested with version 5.0.0 of ZDS II for Z8 Encore! XP MCUs. Subsequent releases of ZDS II may require you to modify the code supplied with this reference design

### Kit Contents

The contents included with this reference design are:

- Buck Converter Battery Charger Design Module
- USB cable, Type A to B
- Buck Converter Battery Charger Reference Design Flyer (FL0144)

### Required Items Not Supplied

- USB SmartCable (Zilog PN: ZUSBSC0001ZACG)
- 3.7V lithium-ion battery

## World of Motors Reference Design

The World of Motors (WoM) Reference Design Board is a development platform built on Zilog's series of Mini-Z stamp modules. It provides engineers, students, and enthusiasts a simple-to-use platform for developing prototypes and projects related to motor control.

The WoM Board is designed to work with Zilog's series of Mini-Z modules. Additionally, it is compatible with the basic stamp modules available from multiple vendors. The WoM reference board includes an FTDI USB-to-serial converter for serial communication capability.

This reference design includes build options for using the Mini-Z shell or for Standalone operation. The Mini-Z shell provides a console with command line instructions and the code is uploaded and executed through the console, via command line instructions. The standalone code requires the use of the ZDS tools to flash the Mini-Z (overwriting the shell code). The standalone version provides menu-driven commands to control the motors.

### Associated Documentation

RD0036	World of Motors Reference Design
RD0036-SC01	Source Code of the World of Motors Reference Design

### Related Documentation

RD0006	Mini-Z ZNEO 28-Pin Module Reference Design
RD0006-SC01	Mini-Z Library
RM0061	Mini-Z Shell and Flash Loader Reference Manual
PS0220	ZNEO Z16F Series Product Specification
UM0188	ZNEO CPU Core User Manual
UM0181	USB Smart Cable User Manual

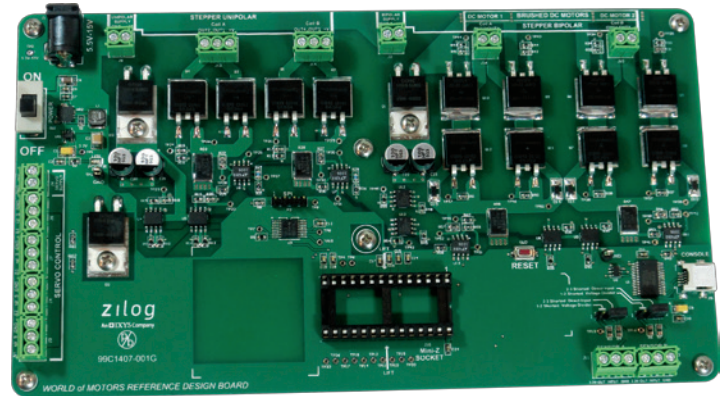

### Features

- Controls the following motors:
  - DC brush motor
  - Servo motor
  - Unipolar stepper motor
  - Bipolar stepper motor
- Wirelessly controls motors using Mini-Z ZPAN or Mini-Z WLAN modules
- Provides console communication

### Applications

- Robotics
- Security locks
- Fans
- Navigation systems
- Instrumentation
- Automated sprinkler systems

### Kit Contents

- Mini-Z ZNEO 28-Pin Module
- Mini-Z World of Motors Design Board
- USB SmartCable
- Mini-Z to Standard debug adapter
- USB cable (A male to Mini-B male)
- DIP Package Extractor

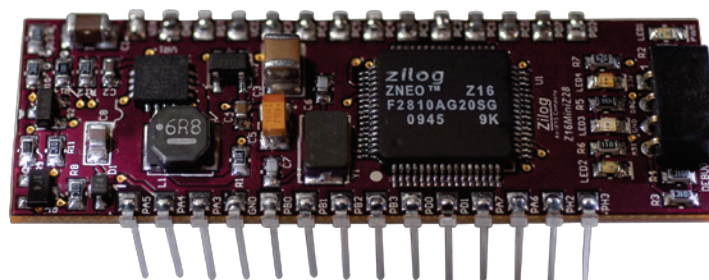



## Mini-Z Solid State Relay Design Board Reference Design

The **Mini-Z Solid State Relay (SSR) Design Board**, a complete and easy-to-use development platform for Zilog's series of Mini-Z stamp modules, is designed to provide engineers, students and enthusiasts a simple-to-use platform for developing prototypes and projects ranging from HVAC controls to animated control systems. Engineered to capitalize on the advanced functionality of the Z16MiniZ28 Module, the Design Board exposes all of the Module's pins to add external functionality for even more creative projects.

The SSR Design Board is compatible with other vendors' modules such as the Basic ATOM stamp and the Parallax BasicSTAMP. In essence, you can begin your project with what you already have and add the Mini-Z Module later when you are ready for its extra features. The SSR Design Board uses a USB-to-serial converter so that you no longer need to find a converter or a serial port. The Design Board is designed to be operated by either a 9V battery or an external power supply and uses a USB-to-serial converter so that you no longer need to find a converter or a serial port.

### Potential Applications

- Animated control system: up to 8 individual props
- Audio device control
- Pneumatic controls
- And many more!

### Associated Documentation

- Mini-Z WLAN 28-Pin Module Reference Design (RD0005)
- Mini-Z ZNEO 28-Pin Module Reference Design (RD0006)
- Mini-Z Library (RD0006-SC01)
- Mini-Z Solid State Relay Design Board (RD0007)
- Mini-Z Z-PAN 28-Pin Module Reference Design (RD0009)

### Related Documentation

- ZNEO Z16F Series Product Specification (PS0220)
- Mini-Z ZNEO Shell and Flash Loader Reference Manual (RM0061)
- Mini-Z WLAN Shell Reference Manual (RM0062)
- Mini-Z Z-PAN Shell and Flash Loader Reference Manual (RM0063)
- USB SmartCable User Manual (UM0181)
- ZNEO CPU Core User Manual (UM0188)

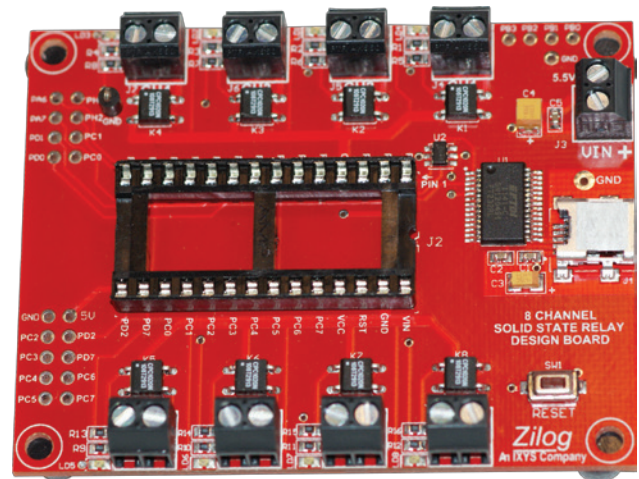

### Mini-Z Solid State Relay Design Board Features

- Controls up to 8 optically isolated solid state relays to drive your devices
- USB serial communications: no more serial cables required
- Operated by battery or external power
- Compatible with the Parallax Basic STAMP programming boards, the BasicMicro ATOM Pro and \*Zilog's series of Mini-Z modules
- Each pin is accessible to add functionality through breadboards and cables to additional boards

\*Zilog's series of Mini-Z 28-pin modules includes the **Mini-Z Z-PAN Module**, the **Mini-Z ZNEO Module** and the **Mini-Z WLAN Module**.

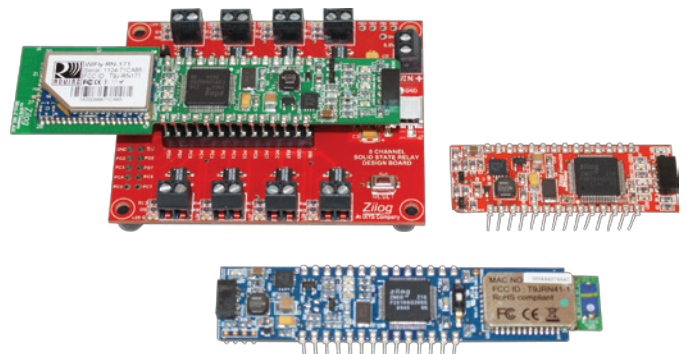

The products associated with the Mini-Z Solid State Relay Design Board are available individually or as a kit and can be ordered from the Zilog Store.

### Mini-Z ZNEO SSR Kit Contents

- Mini-Z ZNEO 28-Pin Module
- Mini-Z Solid State Relay Design Board
- USB Smart Cable
- Mini-Z to standard debug adapter
- USB cable (A male to Mini-B male)
- DIP Package Extractor



Embedded in Life

An IXYS Company



## Mini-Z USB Design Board and Development Kit Reference Design

Zilog's Mini-Z USB Design Board provides a reference design to incorporate USB host and peripheral functionality with Zilog's portfolio of Mini-Z modules. Its hardware design uses a Max3421E USB transceiver to provide an interface to the USB communications with supporting power-limiting and connection circuitry. The design also incorporates a Secure Digital (SD) card using its SPI interface.

The Mini-Z USB Design Board firmware includes host functionality for USB mass storage devices and Secure Digital (SD) card support. The Mini-Z USB Design Board includes all of the hardware necessary to develop prototypes and projects incorporating the host and peripheral functions on Zilog's wide selection of MCUs.

### Potential Applications

- Secure Digital-to-USB converter
- Adding removable storage to Zilog MCU projects
- Adding USB Human Interface Device (HID) input for Zilog MCU projects

### Associated Documentation

Mini-Z USB Design Board Reference Design (RD0030)  
Source Code for the Mini-Z USB Design Board Reference Design (RD0030-SC01)

### Related Documentation

ZNEO Z16F Series Product Specification (PS0220)  
Mini-Z ZNEO 28-Pin Module Reference Design (RD0006)  
Mini-Z Library (RD0006-SC01)  
Mini-Z ZNEO Shell and Flash Loader Reference Manual (RM0061)  
USB SmartCable User Manual (UM0181)  
ZNEO CPU Core User Manual (UM0188)

The source code file associated with this application note, RD0030-SC01, is available free for download from the Zilog website. This source code has been tested with version 5.0.1 of ZDS II for ZNEO MCUs. Subsequent releases of ZDS II may require you to modify the code supplied with this application.

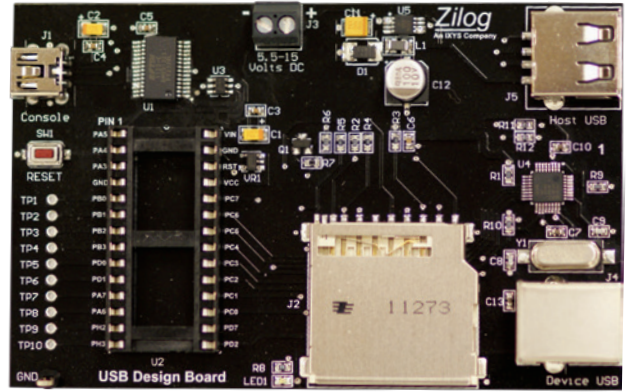

### Mini-Z USB Design Board Features

- Low/full speed USB host capability
- Secure Digital (SD) card
- Full-speed USB peripheral capability
- USB serial communications

### Hardware

The Mini-Z USB Design Board hardware design uses a Max3421E USB transceiver to provide an interface to USB communications. The MAX3421E contains the digital logic and analog circuitry necessary to implement a full-speed USB peripheral or a full-/low-speed host compliant to USB Specifications Revision 2.0. An internal serial interface engine handles the low-level USB protocol details such as error checking, bus retries, and frame packets. The interface to the MAX3421E is the SPI interface.

The **Mini-Z USB Design Board Kit (Z16F28UB100KITG)** includes everything you need to start working with your Board right out of the box, which includes the following items:

- Mini-Z ZNEO 28-Pin Module
- Mini-Z USB Design Board
- USB SmartCable
- Mini-Z to standard debug adapter
- USB cable (A male to Mini-B male)
- DIP Package Extractor





Embedded in Life

An IXYS Company

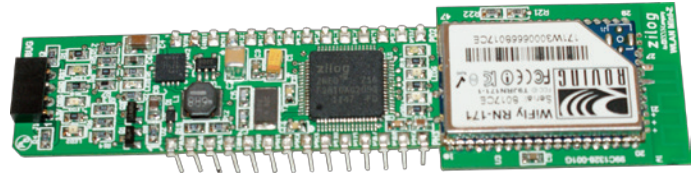

### Mini-Z WLAN 28-Pin Module Features

- Powerful 16-bit CISC microcontroller
- 128 KB of Flash program space with 16-bit access and in-circuit programming
- 4 KB internal RAM with 16 bit access
- 24-bit address space
- 24-bit stack with overflow protection
- 5.5 V to 15 V input with internal 5 V and 3.3 V regulation
- 4-channel, 10-bit ADC
- I<sup>2</sup>C Master/Slave Controller
- Enhanced Serial Peripheral Interface (ESPI)
- Three standard 16-bit timers with capture, compare and PWM capability
- 24 interrupts with programmable priority
- Watchdog Timer with Internal RC Oscillator
- Analog Comparator
- Internal Precision Oscillator

### Mini-Z WLAN 28-Pin Module Reference Design

The Mini-Z WLAN 28-Pin Module is a stand-alone 802.11 b/g TCP/IP Wireless Networking module that is produced in a 28-pin Dual Inline Pin package. The Mini-Z WLAN 28-Pin Module integrates Zilog’s powerful ZNEO microcontroller with a Roving Networks 2.4 GHz RN-171 802.11 b/g WiFly LAN Module.

Designed for the hobbyist, student and engineer to quickly develop prototypes, proof of concept and demonstrations, as well as provide the functionality required for hands-on learning, the Module is designed to be pin-compatible with the Parallax BS2 Series of modules as well as with Basic-Micro-Technology’s Basic ATOM Pro 28-M module. This flexibility allows you to utilize different vendor’s base boards that you may already have in your arsenal.

The Module ships preprogrammed with a boot loader and a control shell that can be accessed through the serial port to allow control of the Module from a terminal program and upload your code hex file through the serial port. The Module is fully compatible with the ZDS II for ZNEO tools suite. You can write your programs in C and Assembly, then compile and upload the hex file through the serial port to the Module. You can also attach the USB SmartCable (included in the Mini-Z WLAN SSR Kit) and have full control over the ZNEO chip, including interactive debugging sessions.

### Associated Documentation

- Mini-Z WLAN SSR Kit Quick Start Guide (QS0084)
- Mini-Z WLAN 28-Pin Module Reference Design (RD0005)
- Source Code for the Mini-Z WLAN 28-Pin Module Reference Design (RD0005-SC01)
- Mini-Z Library (RD0006-SC01)
- Mini-Z Solid State Relay Design Board (RD0007)
- Mini-Z WLAN Shell Reference Manual (RM0062)

### Related Documentation

- ZNEO Z16F Series Product Specification (PS0220)
- Mini-Z ZNEO 28-Pin Module Reference Design (RD0006)
- Mini-Z Z-PAN 28-Pin Module Reference Design (RD0009)
- USB SmartCable User Manual (UM0181)
- ZNEO CPU Core User Manual (UM0188)

The Mini-Z Library file associated with this reference design, RD0006-SC01.zip, is available for download on zilog.com. This file has been tested with version 5.0.0 of ZDS II for ZNEO-powered MCUs. Subsequent releases of ZDS II may require you to modify the code supplied with this reference design.

You may purchase the Mini-Z WLAN 28-Pin Module on its own or the **Mini-Z WLAN SSR Kit**, which contains the following tools, from the Zilog Store.

### Kit Contents

- Mini-Z WLAN 28-Pin Module
- Mini-Z Solid State Relay Design Board
- USB SmartCable
- Mini-Z to standard debug adapter
- USB cable (A male to Mini-B male)
- DIP Package Extractor







Embedded in Life

An IXYS Company



## Mini-Z ZNEO 28-Pin Module Reference Design

Zilog's Mini-Z ZNEO 28-Pin Module is a 28-pin Dual Inline Pin module designed for the engineer, student and enthusiast to quickly develop prototypes, proofs of concept and demonstrations as well as to provide the functionality required for hands-on learning. The Mini-Z ZNEO 28-Pin Module is a single-board computer that is easy to use, and it boasts a wide support base of free application resources. The Module, which features the 16-bit ZNEO CPU-based Z16F2810 MCU, is designed to be pin-compatible with the Parallax BS2 Series of stamp modules and with Basic Micro's Basic ATOM Pro 28-M module. This compatibility in the Module's design allows you to utilize differing vendors' base boards which you may already possess in your development arsenal.

The Mini-Z ZNEO 28-Pin Module ships preprogrammed with a boot loader and a control shell that can be accessed via the serial port. This serial port access allows developers to control the Module from a terminal emulation program (such as HyperTerminal) and to upload user application code as a hex file.

The Module is fully compatible with Zilog's ZDS II IDE version 4.12.0 for ZNEO-based MCUs. You can write your programs in C and Assembly, then compile and upload your hex file via the serial port to the Module. You can also attach a USB SmartCable (not included) and have full control over the ZNEO CPU, including interactive debugging sessions.

### Associated Documentation

- Mini-Z ZNEO 28-Pin Module Reference Design (RD0006)
- Mini-Z Library (RD0006-SC01)
- Mini-Z Solid State Relay Design Board (RD0007)
- Mini-Z ZNEO Shell and Flash Loader Reference Manual (RM0061)

### Related Documentation

- ZNEO Z16F Series Product Specification (PS0220)
- Mini-Z WLAN 28-Pin Module Reference Design (RD0005)
- Mini-Z Z-PAN 28-Pin Module Reference Design (RD0009)
- USB SmartCable User Manual (UM0181)
- ZNEO CPU Core User Manual (UM0188)

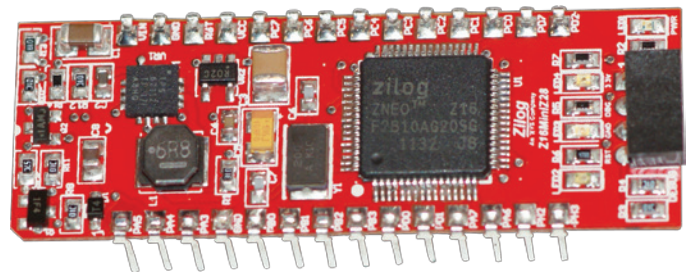

### Mini-Z ZNEO 28-Pin Module Features

- Powerful 16-bit CISC microcontroller
- 128 KB of program space (Flash) with 16-bit access and in-circuit programming
- 4 KB internal RAM with 16-bit access
- 24-bit address space
- 24 bit stack with overflow protection
- 5.5 V to 15 V input with internal 5 V and 3.3 V regulation
- 4-channel, 10-bit ADC
- Analog Comparator
- Internal Precision Oscillator
- I<sup>2</sup>C Master-Slave controller
- Enhanced Serial Peripheral Interface (ESPI)
- Three standard 16-bit timers with capture, compare and PWM capability
- 24 interrupts with programmable priority
- Watchdog timer with internal RC oscillator
- And many more!

This Module ships preprogrammed with a boot loader and a control shell and is fully compatible with the ZDS II for ZNEO tools suite, which is available as a free download in the Zilog Store.

Zilog's Mini-Z ZNEO SSR Kit allows you to interface the Mini-Z ZNEO 28-Pin Module with the symbolic debug features of the ZDS II IDE for ZNEO.

You may purchase the Mini-Z ZNEO 28-Pin Module on its own or the **Mini-Z ZNEO SSR Kit**, which contains the following tools, from the Zilog Store.

### Kit Contents

- Mini-Z ZNEO 28-Pin Module
- Mini-Z Solid State Relay Design Board
- USB SmartCable
- Mini-Z to standard debug adapter
- USB cable (A male to Mini-B male)
- DIP Package Extractor





Embedded in Life

An IXYS Company

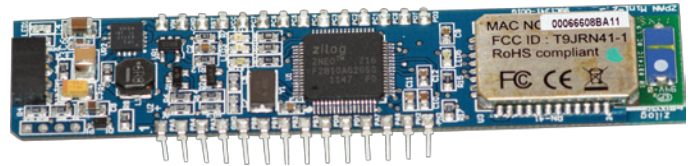

## Mini-Z Z-PAN 28-Pin Module Features

- Powerful 16-bit CISC microcontroller
- 128 KB of Flash program space with 16-bit access and in-circuit programming
- 4 KB internal RAM with 16 bit access
- 24-bit address space
- 24-bit stack with overflow protection
- 5.5 V to 15 V input with internal 5 V and 3.3 V regulation
- 4-channel, 10-bit ADC
- I<sup>2</sup>C Master/Slave Controller
- Enhanced Serial Peripheral Interface (ESPI)
- Three standard 16-bit timers with capture, compare and PWM capability
- 24 interrupts with programmable priority
- Watchdog Timer with Internal RC Oscillator
- On-Chip Debugger
- And many more!

## Mini-Z Z-PAN 28-Pin Module Reference Design

The Mini-Z Z-PAN 28-Pin Module is a stand-alone 802.15 Personal Area Network that is produced in a 28-pin Dual Inline Pin package. The Mini-Z Z-PAN 28-Pin Module integrates Zilog's powerful ZNEO microcontroller with a Roving Networks 2402– 2480 MHz RN-41 Personal Area Network Module.

Designed for the hobbyist, student and engineer to quickly develop prototypes, proof of concept and demonstrations, as well as provide the functionality required for hands-on learning, the Module is designed to be pin-compatible with the Parallax BS2 Series of modules as well as with Basic-Micro-Technology's Basic ATOM Pro 28-M module. This flexibility allows you to utilize different vendor's base boards that you may already have in your arsenal.

The Module ships preprogrammed with a boot loader and a control shell that can be accessed through the serial port to allow control of the Module from a terminal program and upload your code hex file through the serial port. The Module is fully compatible with the ZDS II for ZNEO tools suite. You can write your programs in C and Assembly, then compile and upload the hex file through the serial port to the Module. You can also attach the USB SmartCable (included in the Mini-Z Z-PAN SSR Kit) and have full control over the ZNEO chip, including interactive debugging sessions.

The Mini-Z Library file associated with this reference design, RD0006-SC01.zip, is available for download on [zilog.com](http://zilog.com). This file has been tested with version 5.0.0 of ZDS II for ZNEO-powered MCUs. Subsequent releases of ZDS II may require you to modify the code supplied with this reference design.

Zilog's Mini-Z Z-PAN SSR Kit allows you to interface the Mini-Z Z-PAN 28-Pin Module with the symbolic debug features of the ZDS II IDE for ZNEO.

You may purchase the Mini-Z Z-PAN 28-Pin Module on its own or the **Mini-Z Z-PAN SSR Kit**, which contains the following tools, from the Zilog Store.

## Associated Documentation

- Mini-Z Z-PAN SSR Kit Quick Start Guide (QS0086)
- Mini-Z Library (RD0006-SC01)
- Mini-Z Solid State Relay Design Board (RD0007)
- Mini-Z Z-PAN 28-Pin Module Reference Design (RD0009)
- Mini-Z Z-PAN Shell and Flash Loader Reference Manual (RM0063)

## Kit Contents

- Mini-Z Z-PAN 28-Pin Module
- Mini-Z Solid State Relay Design Board
- USB SmartCable
- Mini-Z to standard debug adapter
- USB cable (A male to Mini-B male)
- DIP Package Extractor

## Related Documentation

- ZNEO Z16F Series Product Specification (PS0220)
- Mini-Z WLAN 28-Pin Module Reference Design (RD0005)
- Mini-Z ZNEO 28-Pin Module Reference Design (RD0006)
- USB SmartCable User Manual (UM0181)
- ZNEO CPU Core User Manual (UM0188)





Embedded in Life

An IXYS Company



## World of Sensors (WoS) Design Board and Development Kit Reference Design

The World of Sensors (WoS) Design Board allows developers greater freedom to design products that may require several types of sensing solutions within the same design. It's a complete and easy-to-use development platform for Zilog's series of Mini-Z stamp modules, and is designed to provide engineers, students and enthusiasts a simple-to-use platform for developing prototypes and projects that will incorporate multiple sensors.

The World of Sensors Design Board includes a world of sensing technology with which you can easily experiment, including seven different sensors, each on different peripherals. It is designed to work with Zilog's Mini-Z modules, which best showcase the interaction of these sensors.

The World of Sensors Board also enables even more creative projects by allowing you to simply swap Mini-Z modules, each of which demonstrates a different type of built-in wireless support. In essence, you can begin your project with any Mini-Z Module that you already have and add other Mini-Z Modules later when you are ready for these modules' unique features.

### Associated Documentation

- World of Sensors Reference Design Quick Start Guide (QS0089)
- World of Sensors Reference Design (RD0012)
- Shell Source Code for the World of Sensors Reference Design (RD0012-SC01)
- Stand-alone Source Code for the World of Sensors Reference Design (RD0012-SC02)

### Related Documentation

- ZNEO Z16F Series Product Specification (PS0220)
- Mini-Z ZNEO 28-Pin Module Reference Design (RD0006)
- Mini-Z Library (RD0006-SC01)
- Mini-Z ZNEO Shell and Flash Loader Reference Manual (RM0061)
- USB SmartCable User Manual (UM0181)
- ZNEO CPU Core User Manual (UM0188)

The World of Sensors Design Board ships as a Board plus a USB cable; Mini-Z modules are sold separately.

\*Zilog's series of Mini-Z 28-pin modules includes the Mini-Z ZNEO Module, the Mini-Z WLAN Module, and the Mini-Z Z-PAN Module.

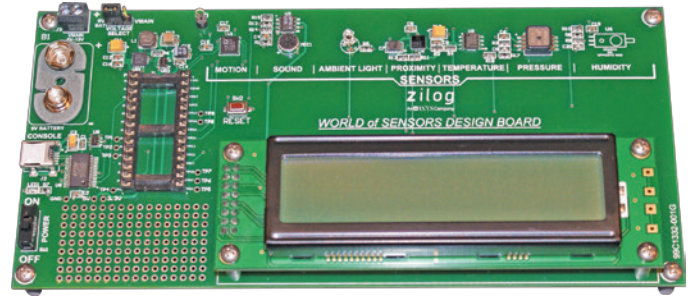

### World of Sensors Design Board Features

- Seven Different Sensors on Different Peripherals
  - Accelerometer
  - Ambient Light Sensor
  - Humidity
  - Microphone
  - Pressure Sensor
  - Proximity Sensor
  - Temperature Sensor
- Serial LCD display
- USB serial communications: no more serial cables required
- Operated by battery or external power
- Compatible with the Parallax Basic Stamp programming boards, the Basic Micro ATOM Pro and Zilog's series of Mini-Z modules

The **World of Sensors Design Kit** (Z16F28WS100KITG) includes everything you need to start working with your Board right out of the box, which includes the following items:

- World of Sensors Design Board
- Mini-Z ZNEO Module
- USB SmartCable
- Mini-Z to Smart Debug Cable adapter
- USB cable (A to Mini-B Male)
- DIP Extractor







Embedded in Life

An IXYS Company



## ZMOTION Occupancy Sensor Reference Design

This ZMOTION Occupancy Sensor reference design demonstrates the use of Zilog's ZMOTION microcontroller and key IXYS components as a passive infrared (PIR) sensor-based motion detector lighting system that can operate in two modes – Occupancy Mode and Vacancy Mode. Both modes can use either PWM or 1–10 V interfaces to control dimmable lighting ballasts. These ballasts typically drive fluorescent/compact fluorescent (CFL), High Intensity Discharge (HID), or High Power LED lighting. A DIP switch is used to select features and modes such as sensitivity, delay time, dim level, pass through mode, vacancy mode, and occupancy mode. Ambient light detection, AC power control, and certain advanced features offered by ZMOTION, such as Pass Through and Hyper Sense, are also supported.

### Features

- Uses the ZMOTION MCU (part number Z8FS040BHH20EG) to perform all motion detection and output control
- 1–10V output with voltage feedback and fault detection (can support up to 25 ballasts)
- PWM output
- AC switch supporting 3 A/220 VAC load
- Ambient light sensor with light gate adjustment
- Occupancy and Vacancy modes
- Pass Through and Hyper Sense detection
- Programmable output level for unoccupied state
- Dimming control of light output level
- LED indicator (for motion detection and external wiring fault detection)
- Push button to toggle light output (manual override)
- 9-position DIP switch for configuration of parameters
- Supports ZMOTION L200 development kit lenses
- USB serial interface for debugging

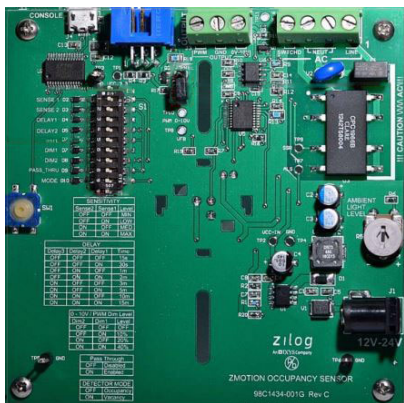

### Associated Documentation

- |             |   |
|-------------|---|
| RD0035      | ZMOTION Occupancy Sensor Reference Design                     |
| RD0035-SC01 | Source Code for the ZMOTION Occupancy Sensor Reference Design |

### Related Documentation

- |        |   |
|--------|---|
| PS0228 | Z8 Encore! XP F082A Series Product Specification    |
| PS0285 | ZMOTION Detection and Control Product Specification |
| PS0286 | ZMOTION Lenses Product Specification                |
| PS0336 | ZMOTION Pyroelectric Sensor Product Specification   |

### Kit Contents

- Occupancy Sensor Design Board
- Power Adapter
- Lenses: ZNCL-9(26), NCL-10IL, ZNCL-3B, NCL-10S, ZNCL-11
- ZMOTION Occupancy Sensor Kit Insert





Embedded in Life

An IXYS Company



## Current-Sensing Power Switch SCR with ZMOTION Control Reference Design

This reference design integrates a ZMOTION Detection Module II and an AC Power Switch Relay based on the IXYS CPC1966 Module to create a motion-controlled current-sensing power switch. The CPC1966 Module includes dual, optically-isolated SCR outputs with enhanced zero-crossing detection circuitry to minimize load distortion. The ZMOTION Detection Module II is based on Zilog's Z8FS040 MCU to provide a 5 m (on-axis) and 6 m (60-degree off-axis) detection pattern.

After motion is detected, the AC switch is activated, providing power to the load until 30 seconds after motion stops, at which time the AC switch is deactivated. The hardware and software components in this reference design can be used as a basis for developing motion-controlled, power-switching solutions.

This Current Sensing Power Switch SCR with ZMOTION Control Reference Design includes the ZMOTION Detection Module II with Fresnel lens. The Base Power Board is a two-layer surface-mount board that provides easy probe access points to all inputs and outputs, allowing the user to quickly connect and measure electrical characteristics and waveforms. The Base Power Board also contains Zilog's Z8F2480 MCU, which is used to generate pulses to keep the CPC1966 Switch active, and perform current sensing and monitoring to detect motion signals from the ZMOTION Detection Module II.

The Board and attached Module are powered from a single-phase AC line with a 90–240 V voltage range. The dimensions of the Base Power Board are 2.85" (L) x 1.85" (W) x 0.7" (H).

### Associated Documentation

- Current Sensing Power Switch SCR with ZMOTION Control Reference Design (RD0023)
- Source Code for the Current Sensing Power Switch SCR with ZMOTION Control Reference Design (RD0023-SC01)

### Related Documentation

- ZMOTION Detection Module II Product Brief (PB0244)
- ZMOTION Detection Module II Reference Design (RD0026)
- ZMOTION Detection Module II Evaluation Kit User Manual (UM0260)

## Current-Sensing Power Switch SCR with ZMOTION Control Features

- 90–240 V AC RMS input voltage range
- Up to 3 A load current
- Overcurrent protection
- Adjustable minimum drop-out current protection
- Less than 2 mA standby current at 120 V AC in an OFF state

## Base Power Board and ZMOTION Detection Module II

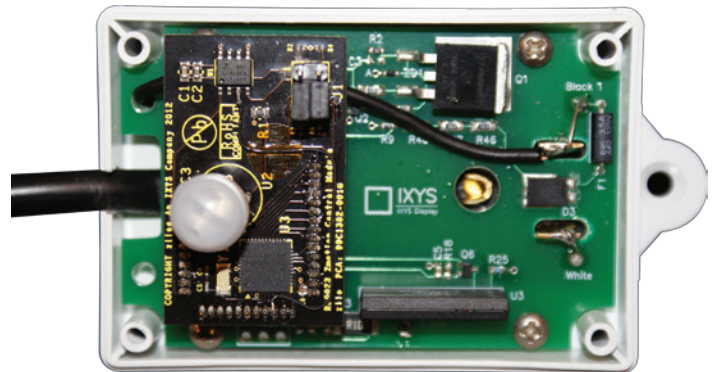

The Base Power Board contains an auxiliary power supply with Depletion Mode MOSFET Q1 (IXTA08N50D2), Zener Diode ZD1, resistors R1 and R2, and Switch Q2 with resistors R16 and R19, which are operated by the MCU. The Board provides approximately 13 V to drive Voltage Regulator U1 with 3.3 V output to power the MCU and the RF block.

MOSFET Q6, connected to the optical input of the CPC1966, turns the Board ON after a pulse from the MCU is received.

The ZMOTION Detection Module II features a Z8FS040 MCU with a pyroelectric sensor and a low-profile Fresnel lens. To learn more about the ZMOTION Detection Module II, please refer to the ZMOTION Detection Module Product Specification (PS0305), which can be found at [www.zilog.com/ZMOTION](http://www.zilog.com/ZMOTION).



Embedded in Life

An IXYS Company



## ZMOTION AC Load Controller Design Module and Development Kit Reference Design

Zilog's ZMOTION AC Load Controller Design Module demonstrates how to use Zilog's ZMOTION MCU in a passive infrared-based motion detector to control power to an AC load in applications such as lighting and HVAC systems. The design uses the 8-pin Z8FS040 MCU to intelligently control a mechanical relay, and provides user adjustments for motion sensitivity, delay time, and ambient light level.

This reference design consists of a single PCB that connects directly to an AC line and controls power to an AC load via a relay. However, to test different lens combinations, or to perform in-circuit programming, consider the ZMOTION AC Load Controller Design Kit, which includes this PCB plus a USB SmartCable and a selection of lenses.

With the continued increase in automated lighting and related applications, the need for a more intelligent, low-cost control system has become apparent. ZMOTION provides this capability.

The Z8FS040 ZMOTION MCU is a fully programmable microcontroller with built-in software-based motion detection algorithms to simplify the development of PIR motion detection designs.

These motion detection algorithms comprise the ZMOTION Engine and run in the background of the MCU while control and status of the Engine is accessed through a software Application Programmer Interface (API). API settings are provided to match the operation of the ZMOTION Engine to each of the lens and pyroelectric sensor combinations provided.

### Associated Documentation

- ZMOTION AC Load Controller Reference Design (RD0028)
- Source Code for the ZMOTION AC Load Controller Reference Design (RD0028-SC01)

### Related Documentation

- Z8 Encore! XP F082A Series Product Specification (PS0228)
- ZMOTION Detection and Control Product Specification (PS0285)
- ZMOTION Lens and Pyroelectric Sensor Product Specification (PS0286)
- USB SmartCable User Manual (UM0181)
- ZMOTION Detection Lens and Pyro Sensor Configuration Guide (White Paper) (WP0018)

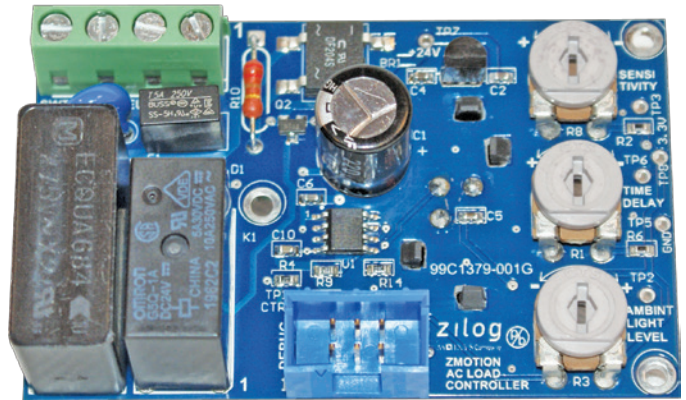

### ZMOTION AC Load Controller Design Module Features

- Controls power to an AC load based on motion detection
- ZMOTION PIR Technology provides immunity to EMI/RFI and other false trigger sources
- 120 VAC/240 VAC 60 Hz/50 Hz input/output
- Switched AC line output for loads up to 5 A (limited by fuse and relay)
- Adjustable sensitivity, delay, and ambient light gate level
- Adjustments can be made from front or back side of board
- Supports six lenses with various patterns and ranges
- Smart Delay feature for pass-through events
- Delayed Detection Mode for harsh conditions
- Small two-layer single-board design, with a 2.7" x 1.7" (6.5cm x 4.3cm) footprint

The ZMOTION AC Load Controller is available as an individual module and as part of a kit; both products can be ordered from the Zilog Store. When ordered as an individual module, the ZMOTION AC Load Controller ships with the ZNCL-3R lens installed.

The ZMOTION AC Load Controller Reference Design Kit contains the following items:

- ZMOTION AC Load Controller Module with ZNCL-3R lens
- USB SmartCable
- Additional lenses: ZNCL-9(26), NCL-10IL, ZNCL-3B, NCL-10S, ZNCL-11
- ZMOTION AC Load Controller Kit Insert Flyer







Embedded in Life

An IXYS Company



## ZMOTION Detection Module II Reference Design

The ZMOTION Detection Module II reference design demonstrates how to use Zilog's ZMOTION Occupancy Detection solution in a PIR-based motion detector module. It also shows how to implement additional hardware and software functions such as a serial interface and configuring the detector using potentiometers.

The ZMOTION Detection Module II (ZDM II) provides an integrated and flexible solution for Passive Infrared (PIR)-based motion detection applications. It includes the Z8FS040 MCU combined with a selection of lenses to fit a range of occupancy detection applications.

The Z8FS040 MCU ships preprogrammed with motion detection software algorithms that comprise the ZMOTION Engine. These algorithms run in the background while control and status of the Engine is accessed through a software Application Programmer Interface (API). Optimized API settings are provided that match the Engine operation to each of the lens and pyroelectric sensor combinations provided.

The use of Passive Infrared (PIR)-based motion detectors has been prevalent in lighting control, energy management, and general occupancy detection applications for a number of years. Zilog's ZMOTION Occupancy Detection Solution employs an architecture that provides a significant advantage over previous approaches, delivering a dramatic improvement in both sensitivity and stability over traditional motion detection designs.

### Associated Documentation

ZMOTION Detection Module II Reference Design (RD0026)  
Source Code for the ZMOTION Detection Module II Reference Design (RD0026-SC01)

### Related Documentation

ZMOTION Detection Module II Product Brief (PB0244)  
ZMOTION Detection Module II Product Specification (PS0305)  
ZMOTION Detection Module II Evaluation Kit User Manual (UM0260)

The source code file associated with this application note, RD0026-SC01.zip, is available free for download from the Zilog website. This source code has been tested with version 5.0.0 of ZDS II for Z8 Encore! XP MCUs. Subsequent releases of ZDS II may require you to modify the code supplied with this reference design.



### ZMOTION Detection Module II Features

- Complete board-level motion detection design supporting the following five lens types:
  - NCL-10L (7 meter wall mount, wide angle) installed
  - NCL-10S (12 meter wall mount, corridor, directional)
  - NCL-9(26) (5 meter wall/ceiling mount, 2:1 diameter-to-height coverage ratio)
  - NCL-3R (ceiling mount, 1.8:1 diameter-to-height coverage ratio)
  - NCL-3B (3 meter wall mount, wide angle)
- Employs a low-cost RE200B dual-element pyroelectric sensor
- Low-cost modular design
- Serial and hardware configuration modes
- Automatic temperature compensation
- Standard 8-pin 0.100" header interface

The ZMOTION Detection Module II Reference Design is based on this architecture.

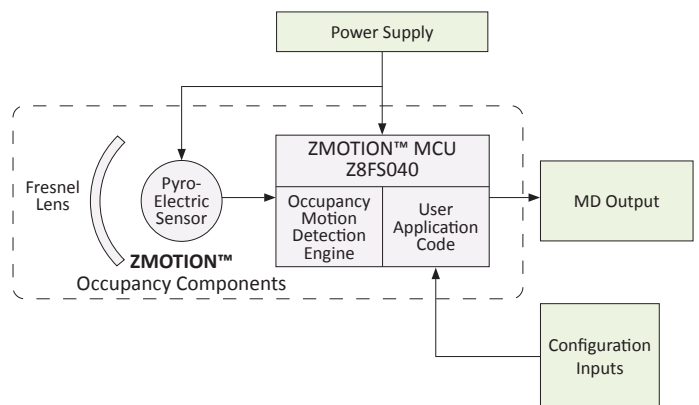



Embedded in Life

An IXYS Company



## ZMOTION Intrusion Detection Reference Design

This reference design demonstrates how to use Zilog’s ZMOTION Intrusion Motion Detection solution in a PIR-based intrusion motion detector. It also shows how to implement additional functions such as anti-mask and power supply supervisory features.

The ZMOTION Intrusion Motion Detection (ZIRD) device provides an integrated and flexible solution for Passive Infrared (PIR)-based security/intrusion motion detection applications. It includes the Z8FS021 ZMOTION Intrusion MCU combined with a selection of lenses to fit a range of intrusion motion detection applications.

The Z8FS021 ZMOTION Intrusion MCU comes preprogrammed with motion detection software algorithms that comprise the ZMOTION Engine. These software algorithms run in the background while control and status of the Engine is accessed through a software Application Programmer Interface (API). Optimized API settings are provided to match Engine operation to each of the lens and pyroelectric sensor combinations provided.

The ZMOTION Intrusion Reference Design (ZIRD) is based on the 20-pin Z8FS021 ZMOTION Intrusion MCU. All functions related to the operation of the detector are handled by the MCU, with the exception of the case tamper which is implemented with a simple lever switch that opens when the front cover is removed.

### Associated Documentation

- ZMOTION Intrusion Detection Reference Design Installation Guide (QS0082)
- ZMOTION Intrusion Detection Reference Design (RD0001)
- Source Code for the ZMOTION Intrusion Detection Reference Design (RD0001-SC01)
- ZMOTION Intrusion Reference Design Lab Findings Report (WP0019)

### Related Documentation

- ZMOTION Intrusion Detection Product Brief (PB0230)
- ZMOTION Intrusion Detection Product Specification (PS0288)
- ZMOTION Intrusion Detection Development Kit Quick Start Guide (QS0078)
- ZMOTION Intrusion Detection Development Kit User Manual (UM0233)
- ZMOTION Detection Lens and Pyro Sensor Configuration Guide (White Paper) (WP0018)

## ZMOTION Intrusion Detection Features

- Complete Intrusion Motion Detection design supporting three lens types:
  - WA 1.2 GI 12 V4: 18 meter, wide angle (installed)
  - LR 1.2 GI 12 V3: 30 meter, corridor
  - VB 1.2 GI V1: 15 meter, vertical barrier
- White light immunity > 12,000 LUX
- Uses low-cost RE200B dual-element pyroelectric sensor
- Automatic temperature compensation
- 12 kg/30 kg selectable pet immunity
- Selectable NORMAL and PULSE modes
- Auto LED
- Anti-mask demonstration
- Power supply supervisory

## ZMOTION Design Architecture

With the ZMOTION Intrusion Detection Solution (see below figure), the pyroelectric sensor is interfaced directly to the Z8FS021 MCU without any AC coupling, gain or filtering. This arrangement allows the MCU to work with the true, unmodified signal and see the real time effects caused by shifts in DC offset, transients and other non-motion-based signal changes. No temperature compensation is required, and the Status LED is used as the sensor for white light immunity, resulting in a lower component count design. The ZMOTION Intrusion Detection Reference Design is based on this architecture.

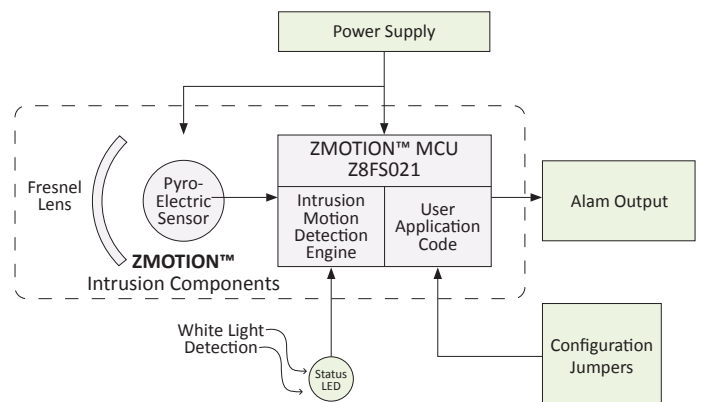



Embedded in Life

An IXYS Company



## Motion Sensing & LED Control Reference Design

The Motion Sensing & LED Control reference design demonstrates how to use Zilog's Z8FS040 ZMOTION MCU with the IXYS LDS8710 High-Efficiency LED Driver and explains how to implement features such as ambient light detection and LED dimming in addition to passive infrared motion detection. It also illustrates how the combined capabilities of both products are an exceptional choice for energy management functions in applications ranging from low-power displays and backlighting to ambient room lighting control.

The source code files associated with this reference design, RD0003-SC01.zip, RD0003-SC02.zip and RD0003-SC03.zip, are available for download on [zillog.com](http://zillog.com). These files have been tested with version 5.0.0 of ZDS II for Z8 Encore! XP MCUs. Subsequent releases of ZDS II may require you to modify the code supplied with this reference design.

### Associated Documentation

Motion Sensing & LED Control with a ZMOTION/ IXYS Display (RD0003)

Source Code #1 for the Motion Sensing & LED Control with a ZMOTION/ IXYS Display Reference Design (RD0003-SC01)

Source Code #2 for the Motion Sensing & LED Control with a ZMOTION/ IXYS Display Reference Design (RD0003-SC02)

Source Code #3 for the Motion Sensing & LED Control with a ZMOTION/ IXYS Display Reference Design (RD0003-SC03)

### Related Documentation

ZMOTION Detection and Control Product Specification (PS0285)

ZMOTION Lens and Pyroelectric Sensor Product Specification (PS0286)

ZMOTION Intrusion Detection Reference Design (RD0001)

eZ8 CPU Core User Manual (UM0128)

ZMOTION Detection Lens and Pyro Sensor Configuration Guide (White Paper) (WP0018)

This Motion Sensing and LED Control RD consists of a Zilog Z8FS040 ZMOTION MCU and an IXYS LDS8710 High-Efficiency LED Driver mounted on a control board. The ZMOTION Z8FS040 MCU acts as the main controller for this reference design. LED brightness is controlled by a PWM output from the Z8FS040 MCU, with inputs from either a potentiometer, ambient light sensor (ALS), or console via the UART interface (collectively referred to as control switches). Individual project files are provided for each of these three control switch options. The Z8FS040 MCU also directly interfaces to a pyroelectric sensor for its motion detection functions.

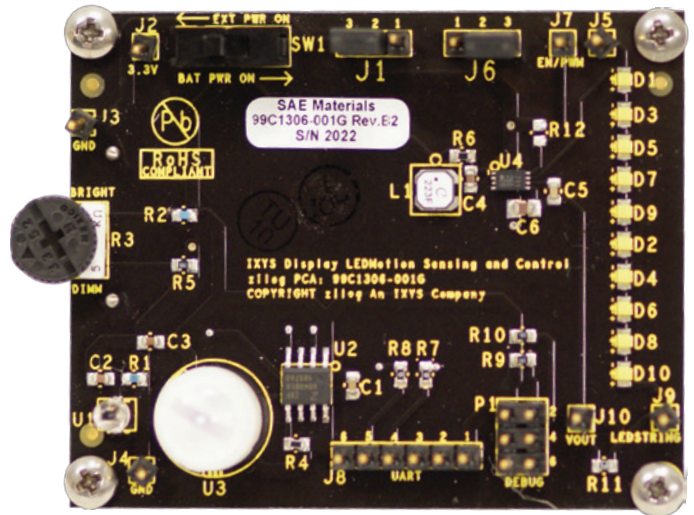

## Motion Sensing & LED Control Features

- Integrated passive infrared (PIR) motion sensing and LED control combined in a single 8-pin Zilog MCU
- Self-contained, single-board solution for motion sensing and LED control
- Motion detection adapts to various lenses with simple header file changes
- Selectable power source of either two AA batteries or an external power supply with operating voltage in the 2.7 V to 3.6 V range
- Ability to switch high-intensity LEDs on and off in response to motion
- Controls LED brightness from three sources:
  - Console commands
  - Potentiometer (control source depends on software build)
  - Ambient light
- Available in handheld size, approximately 2" x 3"

## LDS8710 High-Efficiency LED Driver

The IXYS LDS8710 High-Efficiency LED Driver is a fixed-frequency current-mode boost converter with an internal synchronous rectifier and a cycle-by-cycle switch current limit specifically designed to drive a string of up to 10 white LEDs. Series connection of these LEDs provides constant current and uniform brightness, eliminating the requirement for ballast resistors and factory calibration.

- High-efficiency boost converter with input voltage in the 2.7 V to 5.5 V range
- No external Schottky required (an internal synchronous rectifier is used instead)
- 250 mV current sense voltage
- Drives one LED string with 10 LEDs in series up to 30 mA
- 0.7 MHz switching frequency
- Efficiency greater than 83%
- PWM LED dimming control mode
- Overvoltage, undervoltage, overcurrent and overtemperature protection
- Low shutdown current (< 1  $\mu$ A)
- Available in an 8-pin 2" x 3" x 0.8 mm TDFN package





Embedded in Life

An IXYS Company



## Microstepper Motor Design Board and Development Kit Reference Design

Zilog's Z8F1680 MCU-based Microstepper Motor reference design is a complete and easy-to-use platform that demonstrates the features set of the Z8F1680 Microcontroller, which is optimized for microstepper motor control. This Microstepper Motor Reference Design drives a unipolar stepper motor using the Z8F1680 MCU's onboard analog comparators for one-shot feedback current limiting. It also uses the Z8F1680 MCU's multichannel timer as a microstepper sine/cosine current generator.

Microstepping, or sine/cosine microstepping, is a stepper motor drive technique in which the current in the motor windings is controlled to approximate a sinusoidal waveform. Microstepping produces a much smoother rotation than that of a full step drive, plus it provides greater resolution and freedom from resonance problems because it involves more steps per revolution.

With microstepping, varying amounts of current are applied to a motor's coils so that the magnetic field smoothly transitions from one polarity to the next. Each full step is divided into several microsteps of varying current to produce a larger number of magnetic fields that the rotor can align with. The result is a smoother motor rotation, quieter operation, and greater motor resolution.

### Associated Documentation

Control a Microstepper Motor with the Z8F1680 MCU Reference Design (RD0004)

Source Code for the Control a Microstepper Motor with the Z8F1680 MCU Reference Design (RD0004-SC01)

### Related Documentation

Z8 Encore! XP F1680 Microstepping Controller Application Note (AN0272)

Z8 Encore! XP F1680 Series Product Specification (PS0250)  
eZ8 CPU Core User Manual (UM0128)

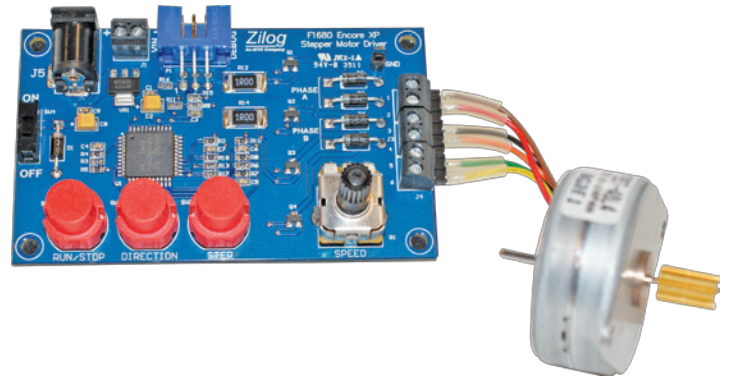

### Microstepper Motor Design Board Features

- Stepper motor
- Sine/cosine microstepping
- Current limiting
- Speed control
- Directional control of the motor
- One-step advancing of the motor
- Current generator for each coil
- Base Power Board

### Potential Applications

- Precision surgical procedures
- Motorized position camera
- HVAC coolant control
- Robotic arms for a factory production line
- Robot controls
- Valve control for a fluid control system
- Motorized curtains or window cover controls
- Laser or optical precision positioning equipment

The Microstepper Motor Reference Design is available as an individual board and as part of a kit, as shown in the Kit Contents that follows. Both products can be ordered from the Zilog Store.

- Microstepper Motor Reference Design Board
- Stepper Motor PF35T-48L4
- AC-5VDC Power Adapter

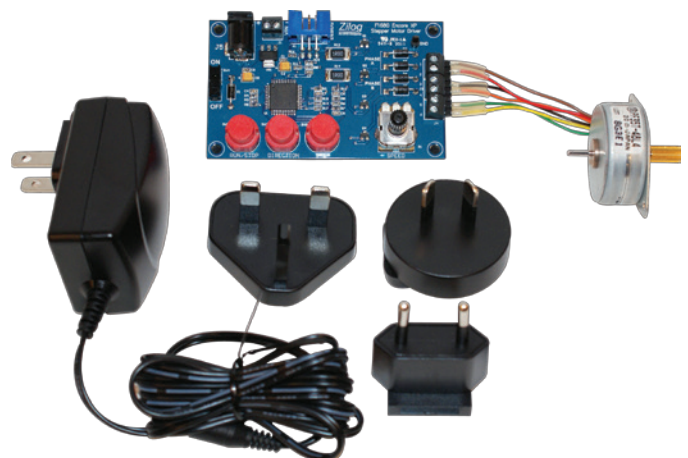

## Zilog Educational Platform and Kit Education Solutions

The Zilog Educational Platform is designed to offer a comprehensive educational advantage to students who are pursuing a degree in the electronics and computer sciences. It is an electronics development system for learning and teaching at the university level, yet can also serve the needs of students at the high school level. The core of the Zilog Educational Platform is Zilog's Z16F2810 MCU, a 16-bit Flash chip based on Zilog's ZNEO CPU.

The Platform's robust educational capabilities allow students to learn about microcontroller architecture, language programming, wireless communication, analog-to-digital conversion, sensing technologies and security encryption methods; students can also experiment with creating industrial lighting and motor control applications. The Platform can also be configured as a data acquisition and remote control system; it ships with a command shell that allows control of the Platform without the need for additional programming.

The Educational Platform's design layout allows students to use it with intuitive ease, thereby saving time, energy and money. The Platform is complete in all aspects of its functionality, with attention applied to many of the Platform's details. These details include its integrated audio buzzer and a jumper that, when removed, can disable the backlight display from the LCD panel when power savings are important. The Platform's battery power source allows for mobile capability when considering projects in the field.

In addition to the Zilog documentation listed below, **Programming The Zilog ZNEO Microcontroller By Example: Volume 1 - Getting Started**, a Kindle book authored by Dan Eisenreich, is a helpful guide to understanding and programming the ZNEO MCU. Find your copy today on Amazon.com.

Operation of the Zilog Educational Platform assumes a functional knowledge of basic computer principles on the part of the student.

### Associated Documentation

Zilog Educational Platform User Manual (UM0255)  
 Zilog Educational Shields User Manual (UM0256)

### Related Documentation

ZNEO Z16F Series Product Specification (PS0220)  
 Zilog Developer Studio II - ZNEO User Manual (UM0171)  
 ZNEO CPU Core User Manual (UM0188)

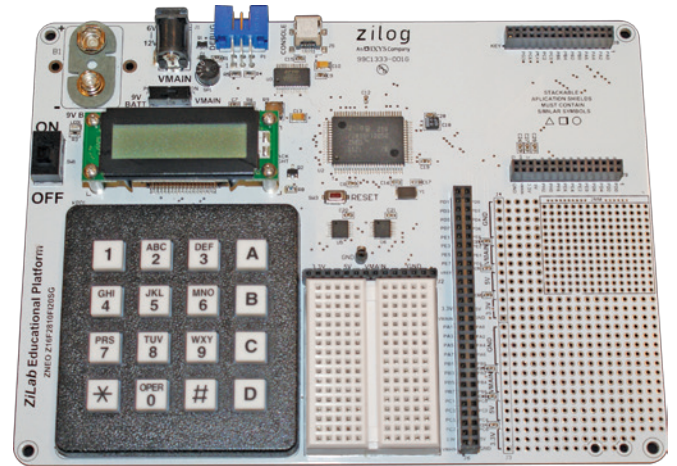

### Zilog Educational Platform Features

- Input via a 16-key pad and/or a PC console application
- Output through a 16x2 LCD and/or standard PC monitor
- Dual-format breadboards, both standard and solderless
- Dual main power options: 6 V–12 V wall outlet or 9 V battery for mobile operation
- Three voltages available to the breadboard when the Platform is powered with the included 9 V wall outlet:
  - V<sub>MAIN</sub>
  - 3.3 V
  - 5 V with a maximum current of 2.0 amps
- 47 GPIO lines
- Stackable application shield modules
- Preprogrammed command shell
- I/O signal access connector
- Buzzer

The **Zilog Educational Platform** does not include a USB SmartCable, which is required for working with the ZED Application Shields. However, this item is available in the **Zilog Educational Platform Kit**. The USB SmartCable and downloadable driver files, plus the ZED Test Shield, World of Sensors, Z-PAN, and WLAN Application Shields, are also available separately in the Zilog Store.

### Kit Contents



- Educational Platform Breadboard
- System ZED Test Shield
- USB SmartCable for debugging purposes
- USB (A to Mini-B) cable
- Wall power adapter
- 9V battery
- Flash drive



Embedded in Life  
An IXYS Company



## Documentation

F08xA Series Product Brief (PB0159)  
F082A Series Product Specification (PS0228)  
F082A Series User Manual (UM0186)

F64xx Series Product Brief (PB0124)  
F64xx Series Product Specification (PS0199)  
F64xx Series User Manual (UM0151)

## Battery Charging Solutions

### Z8 Encore! XP® 8-bit Microcontrollers

Zilog's Z8 Encore! XP® Flash Microcontrollers integrate numerous functionalities for intelligent battery charging applications. Add the free development tool suite of ZDSII and you have a complete embedded control solution. Z8 Encore! XP® provides adaptive charging with automatic switch over from a constant current charge to a constant voltage mechanism and delta-V or peak-V termination methods. This is controlled by a feedback loop using the PWM output of the 16-bit multi-mode timer and the high resolution Sigma/Delta ADC, which continuously monitors both the output voltage and current of the DC-DC converter and battery current.

The Z8 Encore! XP® can perform additional tasks, such as communication, control, status/event logging and system monitoring. The extra PWM can be used to drive a DC motor with over-current protection provided by the on-chip comparator. Interface to external sensors with the high resolution Sigma/Delta ADC (which support differential inputs and chopping). Use the 8-pin device for dedicated battery charging applications or select from 8/20- or 28-pin SOIC and SSOP packages to optimize your design.

### Z8 Encore! XP® Z8F082A Series Block Diagram

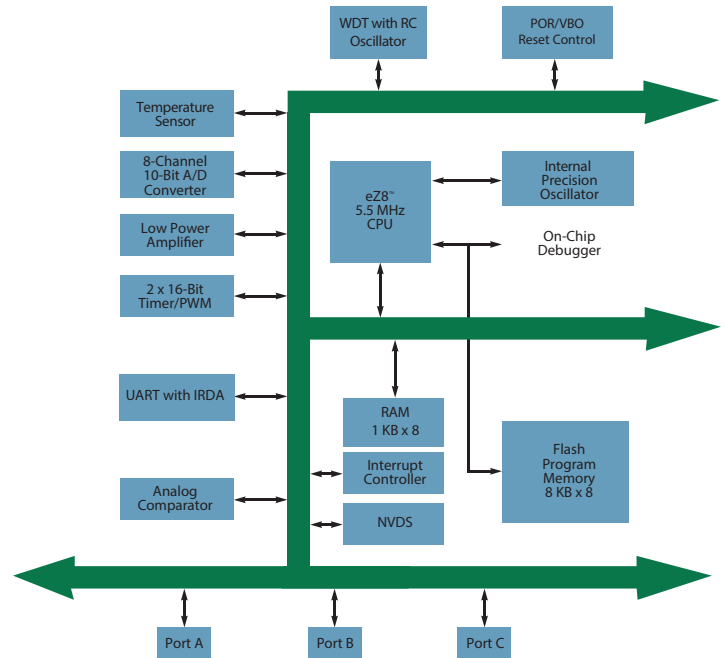

### Z8 Encore! XP® Z8F082A Series Features and Benefits

- High Performance 20MHz eZ8® CPU Core
- 1KB to 8KB Flash program memory
- 256B to 1KB of Register RAM
- Up to 128B of NVDS
- Internal 5.53MHz +/-2% Oscillator with Failsafe
- On-Chip Temperature Sensor
- Analog comparator
- Low Power Operational Amplifier
- Two 16-bit Multi-Mode Timers
- Full-Duplex UART with 9-bit mode & constant-current IrDA options
- Direct LED drive with Programmable CC
- Up to 8-Channel Sigma/Delta ADC
- Single Pin On-Chip Debugger
- Watch Dog Timer
- Operation from 2.7V to 3.6V
- Extended and standard temperature versions
- 8-, 20-, and 28-pin packages with up to 25 GPIOs

### Application Notes & Source Code Files

#### Develop with Z8F082A Series MCUs

- A Simple Console Application for Z8 Encore! XP MCUs (AN0342, AN0342-SC01)
- AES 128-Bit Implementation with Z8 Encore! XP Microcontrollers (AN0338, AN0338-SC01, AN0338-SC02)
- Boot Loader for the Z8F082A and Z8F1680 MCUs (AN0328, AN0328-SC01)
- Z8 Encore! XP-Based UPS Battery Charger (AN0306, AN0306-SC01)
- Z8 Encore!-Based SLA Battery Charger (AN0223, AN0223-SC01)
- Z8 Encore! XP-Based NiMH Battery Charger (AN0222, AN0222-SC01)
- Z8 Encore! XP-Based NiCd Battery Charger (AN0221, AN0221-SC01)
- Z8 Encore! XP-Based Lithium Ion Battery Charger (AN0218, AN0218-SC01)

#### Develop with Z8F64xx Series MCUs

- A Performing Data Conversions Using Z8F64xx Series MCUs (AN0352, AN0352-SC01)
- A Simple Console Application for Z8 Encore! XP MCUs (AN0342, AN0342-SC01)
- DTMF Signal Detection Using Z8 Encore! XP F64xx Series MCUs (AN0335, AN0335-SC01)
- Generating DTMF Tones Using Z8 Encore! MCU (AN0248)
- Z8 Encore!-Based Battery Charger (AN0137, AN0137-SC01)



**eZ8 Core.** Zilog's advanced register-based eZ8 8-bit CPU core running at 20MHz with memory-to-memory architecture, modified Harvard architecture and excellent math performance.

**Memory.** Available with up to 8KB of nonvolatile Flash memory, up to 1KB of Static RAM (SRAM) and up to 128 bytes of Nonvolatile Data Storage (NVDS).

**Up to 8 Channels of 10-bit ADC.** The conversion of an analog input signal to a 10-bit binary number.

**Two 16-Bit Timers with Capture/Compare/PWM.** 16-bit reloadable timers used for timing, event counting, or PWM signal generation.

**One Analog Comparator.** Generally used for current limiting or overcurrent shutdown when used with a current transformer or sense resistor.

**One Operational Amplifier.** The operational amplifier is a two-input, one-output operational amplifier with an open loop gain of 10,000 (80 dB) which is ideal for current levelshifting and amplification of ADC current samples.

**One UART port with IrDA Option.** For external or peripheral communications.

**Oscillator Supports either Internal IPO or External Crystals and Ceramic Resonators.** The Oscillator can be driven with an external crystal of up to 20MHz or with the 5.33MHz Internal Precision Oscillator (IPO), which requires no external components.

**Up to 25 General-Purpose I/O Pins (GPIO).** Provides sufficient I/O pins for control of multiple input and outputs.

**Watchdog Timer (WDT) with Internal RC Oscillator.** Helps protect against corrupted or unreliable software and other system-level problems which may place the MCU into unsuitable operating states.

**Single-Pin On-Chip Debugger.** The on-chip debugger provides advanced debugging features, including: reading and writing of the Register File, reading and writing of program and data memory, setting of breaking points, and execution of eZ8 CPU instructions.

**On-Chip Temperature Sensor.** This sensor is capable of flash recalibration and measures temperature on the die to an accuracy of roughly  $\pm 7^{\circ}\text{C}$  over a range of  $-40^{\circ}\text{C}$  to  $+105^{\circ}\text{C}$ , or  $\pm 1.5^{\circ}\text{C}$  accuracy over the range of  $20^{\circ}\text{C}$  to  $30^{\circ}\text{C}$ .

**On-Chip Low Voltage Detection.** Built-in, with programmable voltage threshold.

**Standard Operating and Programming Voltages.** Operating and programming ranges from 2.7V to 3.6V.

**Multiple Packaging Options.** Available in lead-free packages from an 8-pin SOIC/QFN, 20-pin SOIC/SSOP, and 28-pin SOIC/SSOP.

**Standard and Extended Temperature Ranges.** Available in standard ( $0^{\circ}\text{C}$  to  $70^{\circ}\text{C}$ ) and extended ( $-40^{\circ}\text{C}$  to  $105^{\circ}\text{C}$ ) temperature range.



# Zilog's Encore! XP<sup>®</sup> F082A Series of 8-bit Microcontrollers

For over 35 years, Zilog has been designing and manufacturing application-specific hardware and software solutions for a wide range of industries. The patented design of Zilog's Encore! XP<sup>®</sup> F082A Series incorporates a unique, highly-accurate, multi-channel, sigma-delta, analog-to-digital converter that delivers outstanding performance in sensing applications, such as motion detection, intrusion detection, lighting control, intelligent power control, battery charging, access control, proximity sensing, and gas sensing and monitoring.

To learn more about Zilog's World Class Products, please visit us at [www.zilog.com](http://www.zilog.com)

**zilog** Embedded in Life  
An IXYS Company



Embedded in Life  
An IXYS Company



## BDC Motor Control with Z8 Encore!<sup>®</sup> Microcontrollers

### Z8F0830/Z8F083A Series Microcontrollers

The Z8 Encore! Family offers several devices that meet the needs of universal and brushed DC motor control, along with basic fan control. The Z8F0830 and Z8F083A devices were designed for these types of motors and include an optimized 8-bit eZ8 core, direct memory-to-memory arithmetic operation, a flexible Internal Precision Oscillator (IPO), and a fast ADC.

If your design requires more precision, the Z8F083A MCU takes all of the performance and key peripheral features of the Z8F0830 and adds a more optimized peripheral set that specifically caters to applications that require faster response times. This enhanced Z8F083A peripheral set enables critical motor control loop operations, for example, that accommodate for features such as current and temperature monitoring that are crucial for motor control applications.

Both the Z8F0830 and Z8F083A Series devices are pin-for-pin compatible to allow you to select the best device for your application. The Z8F0830 and Z8F083A Series MCUs are also suitable for digital power management, battery charging and environmental sensor applications. Both are also pin-for-pin compatible with the F082A family.

### Z8F0830/Z8F083A Series Features and Benefits

- 20 MHz eZ8 CPU
- Up to 12KB Flash memory with in-circuit programming capability
- Up to 256B register RAM
- Up to 100B Non-Volatile Data Storage (NVDS)
- Up to 25 I/O pins depending upon package
- Internal Precision Oscillator (IPO): 5.33MHz (F0830)/20.0MHz (F083A)
- External crystal oscillator
- Two enhanced 16-bit timers with capture, compare and PWM capability
- Watchdog Timer (WDT) with dedicated internal RC oscillator
- Single-pin On-Chip Debugger (OCD)
- Optional 8-channel, 10-bit Analog-to-Digital Converter (ADC)
- On-chip analog comparator
- Up to 17 interrupt sources
- Voltage Brown-Out (VBO) protection
- Power-On Reset (POR)
- 2.7V to 3.6V operating voltage
- Up to thirteen 5V-tolerant input pins
- 20- and 28-pin packages
- 0°C to +70°C standard temperature range and -40°C to +105°C extended temperature operating ranges

## Documentation

Product Brief (PB0208)  
User Manual (UM0206)

Product Specification (PS0251)

### Z8 Encore!<sup>®</sup> Z8F083A Series Block Diagram

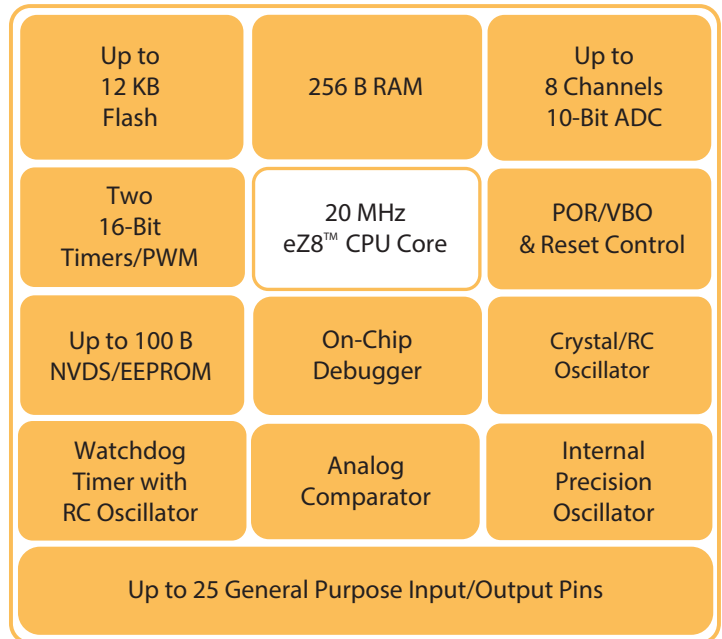

### Application Notes & Source Code Files

An Interrupt-Driven UART for Z8 Encore! XP and Z8 Encore! MC MCUs (AN0330, AN0330-SC01)

An OLED Interface Using the Z8 Encore! XP Series of MCUs (AN0329, AN0329-SC01)

NVDS Operation in the Z8 Encore! and Z8 Encore! XP Microcontrollers (AN0310, AN0310-SC01, AN0310-SC02)

Using the Timer Functions of the Z8 Encore! and Z8 Encore! XP Family of Microcontrollers (AN0291, AN0291-SC01, AN0291-SC02)

Implementing SPI Master and Slave Functionality Using the Z8 Encore! F083A MCU (AN0267, AN0267-SC01)

Software I2C Master and Slave Mode Support for Z8 Encore! F0830/F083A MCUs (AN0266, AN0266-SC01)

Control a Cordless Drill Motor and Battery Charger Using Z8 Encore! F0830 Series (AN0255, AN0255-SC01)

Migration from the Z8 Encore! F0830 Series MCU to the F083A Series MCU (AN0245, AN0245-SC01)

**eZ8 Core.** Zilog's advanced register-based eZ8 8-bit CPU core, running at 20MHz with memory-to-memory architecture, modified Harvard architecture, and excellent math performance.

**Memory.** Available with up to 12KB of nonvolatile Flashmemory, 512 bytes of SRAM (static RAM), and 100 bytes of Non-Volatile Data Storage (NVDS).

**Up to 8-channel 10-bit ADC.** The conversion of an analog input signal to a 10-bit binary number occurs in as low as 2.8µs. Time stamping of the conversion makes the ADC ideal for current sampling and back-EMF sensing.

**Two 16-bit Timers with Capture/Compare/PWM.** A 16-bit reloadable timer used for timing, event counting, or PWM signal generation.

**One Analog Comparator.** Generally used for current limiting or overcurrent shutdown when used with a current transformer or sense resistor.

**Oscillator Supports either IPO or External Crystals and Ceramic Resonators.** The oscillator can be driven with an external crystal of up to 20MHz or with the 5.33MHz (F0830)/20.0MHz (F083 A) Internal Precision Oscillator, which requires no external components.

**25 General-Purpose I/O Pins (GPIO).** Provides sufficient I/O pins for control of Brushed DC Motors with external inputs and outputs.

**Watchdog Timer (WDT) with Internal RC Oscillator.** Helps protect against corrupted or unreliable software and other system-level problems that may place the MCU into unsuitable operating states.

**Single-Pin On-Chip Debugger.** The on-chip debugger provides advanced debugging features, including: reading and writing of the Register File, reading and writing of program and data memory, setting of breaking points and execution of eZ8 CPU instructions.

**Standard Operating and Programming Voltages.** Operating and programming ranges from 2.7V to 3.6V.

**Standard 20-Pin and 28-Pin Packaging.** Available in a compact SOIC, SSOP, PDIP and QFN lead-free packages.

**Standard and Extended Temperature Ranges.** Available in standard (0°C to 70°C) and extended (-40°C to 105°C) temperature ranges.



**zilog**  
Embedded in Life  
An IXYS Company

# Go With The Best In Motor Control!

## Zilog Motor Control Solutions

- Wide range of microcontrollers for your Motor Control applications
- Highly-optimized instruction set that achieves higher performance per clock cycle, with less code space and lower overhead than competing architectures
- World-class development environment for ease of implementation

<p>BLD Universal and Brushed DC Motor Control</p>  <p>Z8 Encore! F083A Series (28-Pin)</p>	<p>Stepper Motor Control</p>  <p>Z8 Encore! XP F1680 Series (28-Pin)</p>	<p>3-Phase/Single-Phase AC Induction and PMSM Motor Control</p>  <p>Permanent Magnet Synchronous Motors Z16FMC Series Motor Control</p>	<p>BLDC Sensor and Sensorless Motor Control</p>  <p>Z8FMC16100 Series Motor Control</p>
---	---	---	--

**The Right Choice for Your Motor Control Needs**

For more information, please visit [www.zilog.com/FlashMC](http://www.zilog.com/FlashMC)



Design With Freedom



**Application Notes & Source Code Files**

Using the Z8 Encore! XP as a Low-Cost Speed Controller for Single-Phase, Permanent Split Capacitor Motors (AN0258, AN0258-SC01)

Vector Control of a 3-Phase AC Induction Motor Using the FMC16100 MCU (AN0247, AN0247-SC01)

Sensorless Brushless DC Motor Control with Z8 Encore! MC Microcontrollers (AN0226, AN0226-SC01, AN0226-SC02)

BLDC Motor Control Using the Z8FMC16100 (AB0005)



**Z8FMC16100 Series Features and Benefits**

- 20MHz eZ8 CPU core
- Up to 16KB Flash program memory
- 512B register SRAM
- Fast 8-channel 10-bit ADC for current sampling and back-EMF sensing
- 12-bit PWM module with 3 complementary pairs or 6 independent PWM outputs with deadband generation and fault trip input
- One 16-bit timer with Capture/Compare/PWM
- One analog comparator for current limiting or over current shutdown
- One operational amplifier provides current level-shifting and amplification for ADC current sampling
- I2C in MASTER, SLAVE, and MULTIMASTER modes
- SPI controller
- UART with LIN and IrDA interface options
- Internal Precision Oscillator (IPO)
- Oscillator supports either internal IPO or external crystals and ceramic resonators
- 17 General-Purpose I/O pins (GPIO)
- Voltage Brown-Out/Power-On Reset (VBO/POR)
- Watchdog Timer (WDT) with internal RC oscillator
- Single-Pin On-Chip Debugger
- In-circuit serial programming operating at 2.7V to 3.6V
- 32-pin QFN and LQFP packages lead-free packaging
- Standard and extended temperature ranges

**BLDC Motor Control with Z8 Encore!® MC Microcontrollers**

**Z8 Encore!® MC Z8FMC16100 Series Flash Microcontrollers**

Optimized for motor control applications, these microcontrollers support the control of single and multiphase motors. They are ideal for sensor or sensorless BLDC motor applications such as high velocity cooling fans and fan trays, large and small appliances, HVAC, power tools, and personal care devices.

The Z8FMC16100 MCU features a flexible pulse width modulator (PWM) module with three complementary pairs or six independent PWM outputs supporting programmable dead-band and fault protection trip input. These provide multiphase control capability for a variety of motor types and ensure safe operation of the motor by providing Pulse-by-Pulse or latched fast shutdown of the PWM pins during fault condition. The ADC has a 2.15µs conversion time and can be triggered automatically by the PWM module reducing interrupt rates and jitter for back EMF or current measurements. Time stamps are automatically captured upon ADC initiation.

**Z8 Encore!® MC Block Diagram**

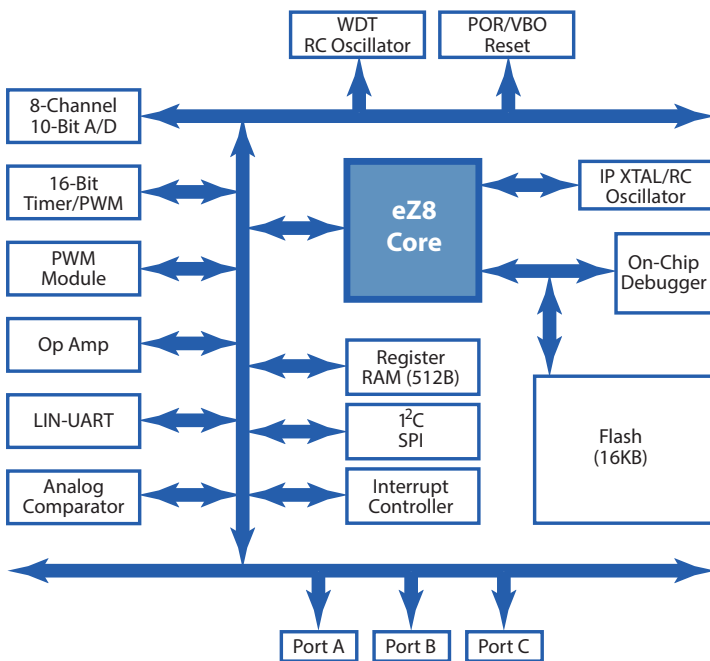

**eZ8 Core.** Zilog’s advanced register-based eZ8 8-bit CPU core running at 20 MHz with memory-to-memory architecture, modified Harvard architecture, and excellent math performance.

**Memory.** Available with up to 16KB of nonvolatile Flash memory and 512 bytes of SRAM (static RAM).

**8-Channel 10-Bit ADC.** The conversion of an analog input signal to a 10-bit binary number occurs in 2.15µs. Time stamping of the conversion makes the ADC ideal for current sampling and back-EMF sensing.

**Six 12-Bit PWM Module Outputs with Deadband Generation and Fault Trip Input.** The Pulse-Width Modulator (PWM) can be configured for 3 complementary PWM output pairs for use with multiple single-phase motors, one 3-phase motor, or 6 independent PWM outputs. Multiple fault inputs can be configured to shut down the PWM module for quick and safe stopping of the motor.

**One 16-bit Timer with Capture/Compare/PWM.** A 16-bit reloadable timer with 7-bit prescaler used for timing, event counting, or PWM signal generation (single or differential).

**One Analog Comparator.** Generally used for current limiting or over current shutdown when used with current transformer or sense resistor.

**One Operational Amplifier.** The operational amplifier is a two-input, one-output operational amplifier with an open loop gain of 10,000 (80 dB), which is ideal for current level-shifting and amplification of ADC current samples.

**One UART with LIN and IrDA Options, SPI, or I2C.** For external or peripheral communications.

**Oscillator Supports either Internal IPO or External Crystals and Ceramic Resonators.** Oscillator can be driven with external crystal of up to 20MHz or with the 5.33MHz Internal Precision Oscillator (IPO) that requires no external components.

**17 General-Purpose I/O Pins (GPIO).** Provides sufficient I/O pins for control of 3 Phase Motors with external inputs and outputs.

**Watchdog Timer (WDT) with Internal RC Oscillator.** Helps protect against corrupted or unreliable software and other system-level problems that may place the MCU into unsuitable operating states.

**Single-Pin On-Chip Debugger.** The on-chip debugger provides advanced debugging features, including: reading and writing of the Register File, reading and writing of program and data memory, setting of breaking points, and execution of eZ8 CPU instructions.

**Standard Operating and Programming Voltages.** Operating and programming ranges from 2.7V to 3.6V.

**Standard 32-Pin Packaging.** Available in a compact 32 pin QFN or LQFP lead-free package.

**Standard and Extended Temperature Ranges.** Available in standard (0°C to 70°C) and extended (-40°C to 105°C) temperature range.

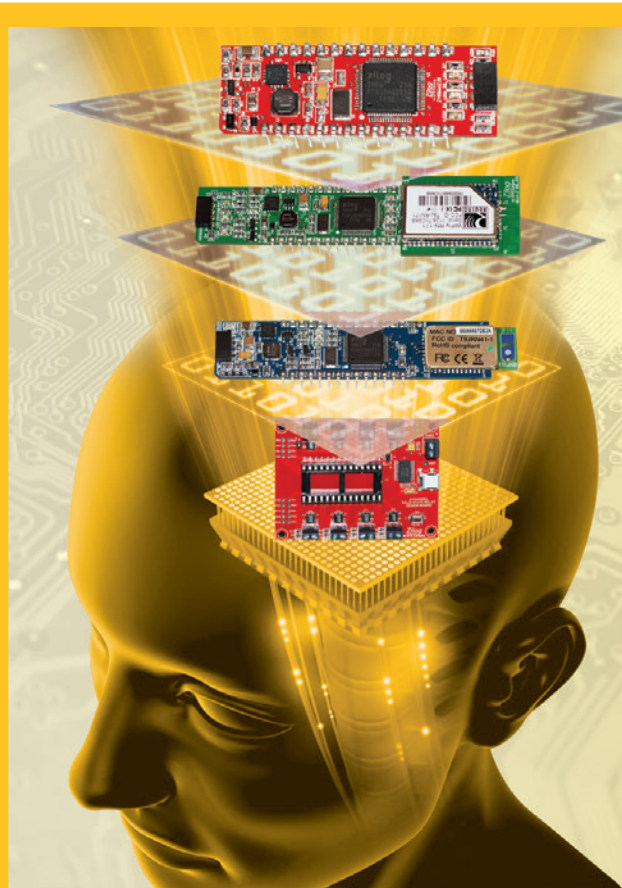

## Design Outside the Box !

### ZILOG'S MINI-Z™ REFERENCE DESIGNS

Mini-Z Modules are 28-pin dual-inline single-board computers that are easy to use and support a wide base of free application resources.

These handy modules feature the 16-bit ZNEO® CPU-based Z16F2810 MCU and are designed to be pin-compatible with various other stamp modules, which allow for flexibility to utilize different vendors' base boards that you may already have in your arsenal.

These Mini-Z stamps also ship with supporting design boards, which provide a mix-and-match capability for creating fast solutions.

Here are just several of the Mini-Z Reference Designs Zilog offers:

Mini-Z Reference Design Products	Part Number
Mini-Z ZNEO 28-Pin Module	Z16F2800100MODG
Mini-Z WLAN 28-Pin Module	Z16F28WF100MODG
Mini-Z Solid State Relay (SSR) Design Board	Z16SSR00100DBDG
Mini-Z ZNEO SSR Kit	Z16SSR00100KITG
Mini-Z WLAN SSR Kit	Z16F28WF100KITG



*Embedded in Life*  
An IXYS Company



Design With Freedom

For more information, please visit [www.zilog.com](http://www.zilog.com)



Embedded in Life

An IXYS Company



## Documentation

Product Brief (PB0229)  
User Manual (UM0234)

Product Specification (PS0287)

## Z16FMC Block Diagram

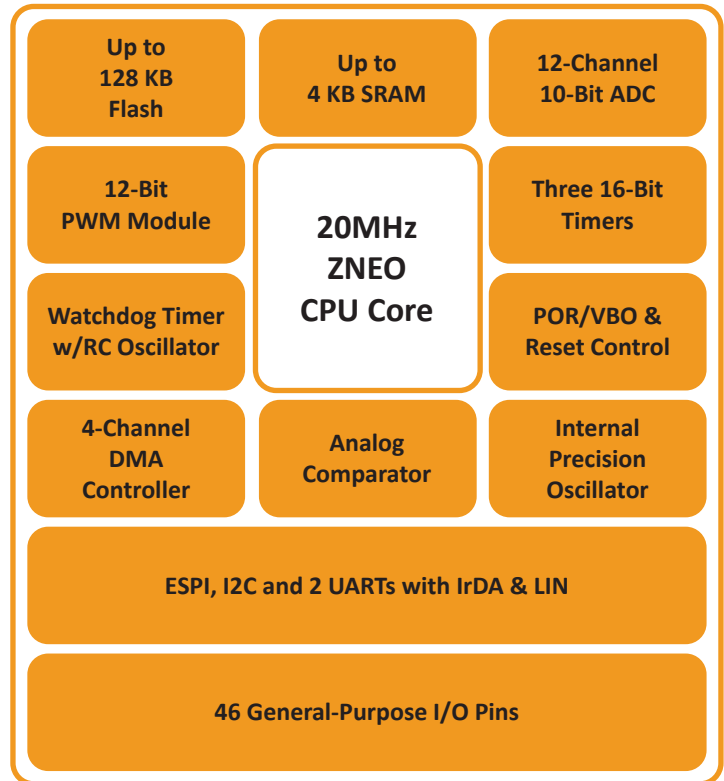

## Z16FMC Series Features and Benefits

- Z16FMC Series 16-bit CPU processor core
- Up to 128KB internal Flash program memory
- Up to 4KB internal RAM
- 12-bit PWM module with three complementary pairs or six independent PWM outputs with deadband generation and fault trip input
- Three standard 16-bit timers with capture, compare, and PWM capability
- Twelve-channel, 10-bit analog-to-digital converter (ADC) with 2.5  $\mu$ s conversion time
- Operational amplifier
- Analog comparator with internal voltage reference
- 4-channel DMA controller with linked-list
- Two full-duplex 9-bit UARTs with support for LIN and IrDA
- Fully integrated internal precision oscillator (IPO)
- I2C master-slave controller
- Enhanced serial peripheral interface (ESPI)
- 2.7V–3.6V operating voltage with 5V-tolerant inputs
- –40°C to 105°C operating range

## AC Induction and Brushless DC Motor Control

### Zilog's Z16FMC Series Flash Microcontrollers

The Z16FMC Series of Flash microcontrollers, based on Zilog's ZNEO CPU, are ideal for 3-phase and single-phase AC induction, permanent magnet synchronous motors (PMSMs), and brushless DC motor control. These motors are typically used in industrial variable frequency drives (VFDs), elevators, fans and pumps, compressors, and large appliances.

The sixteen 32-bit general-purpose registers support complex CISC addressing modes and a single-cycle instruction set that includes capabilities needed to compile compact, efficient, machine code. Low instruction overhead allows you to avoid limitations on CPU bandwidth.

The Z16FMC Series feature a flexible pulse width modulator (PWM) module with three complementary pairs or six independent PWM outputs supporting programmable deadband and fault protection trip input. These provide multiphase control capability for a variety of motor types and ensure safe operation of the motor by providing pulse-by-pulse or latched fast shutdown of the PWM pins during a fault condition.

The separate timer for the PWM module allows the other timers to be used for time-stamp operation so that you can efficiently regulate the speed of the motor.

The ADC has a 2.5- $\mu$ s conversion time and can be triggered automatically by the PWM module, reducing interrupt rates and jitter for back-EMF or current measurements and giving you total control of each PWM cycle of the motor.

Four channels of linked-list DMA supporting memory and peripheral transfers significantly reduce CPU overhead. It can be used to directly control the PWM module when generating complex waveforms.

The Z16FMC Series Development Kit includes everything you need to start working with the Z16FMC family of devices. The kit includes a development board, BLDC motor, USB debugger, and ZDSII integrated development environment.

### Application Notes & Source Code Files

Boot Loader for ZNEO-Based MCUs (AN0325, AN0325-SC01)

Enabling Low Power Modes on the ZNEO CPU (AN0324, AN0324-SC01)

DMA Controller on the ZNEO CPU (AN0314, AN0314-SC01)

Getting Started with ZNEO-Based MCUs (AN0312, AN0312-SC01)

Sensorless Brushless DC Motor Control with the Z16FMC MCU (AN0311) + (AN0311-SC01, AN0311-SC02)





## Zilog Motor Control Technologies

- **Optimized motor control strategies and solutions relevant to today's industry requirements**
- **Embedded software to leverage motor control capabilities**
- **Custom code development**

**20-MHz Z16FMC CPU.** Direct register-to-register architecture that allows each register to function as an accumulator. This capability improves execution time and decreases the required Program Memory.

**Flash Controller.** The Z16FMC products contain 128 KB of internal Flash memory. The Flash controller programs and erases the Flash memory. Z16FMC CPU accesses 16-bits at a time of internal Flash memory to improve the processor throughput. A sector protection scheme allows flexible protection of user code.

**Random Access Memory.** An internal RAM of 4 KB provides storage space for data, variables, and stack operations. Like Flash memory, Z16FMC CPU accesses 16-bits at a time of internal RAM to improve the processor performance.

**Up To 46 I/O Pins, depending upon package.** The Z16FMC Series products support a maximum of 46 port pins (Ports AH) for General Purpose Input/Output (GPIO) operations. Each port contains control and data registers. The GPIO control registers determine data direction, open-drain, output drive current, programmable pull-ups, Stop Mode Recovery functionality, and Alternate Pin functions. Each port pin is individually programmable.

**Internal Precision Oscillator (IPO).** The Internal Precision Oscillator (IPO) with accuracy of +4% full voltage/temperature range is a trimmable clock source that requires no external components.

**External Crystal Oscillator.** The products in the Z16FMC Series contain an on-chip crystal oscillator for use with external crystals with 32 kHz to 20 MHz frequencies. In addition, the oscillator supports external RC networks with oscillation frequencies up to 4 MHz or ceramic resonators with frequencies up to 8 MHz. The on-chip crystal oscillator can be used to generate the primary system clock for the internal Z16FMC CPU and the majority of the on-chip peripherals.

**12-Bit PWM Module.** Three complementary pairs or six independent PWM outputs with deadband generation and fault trip input.

**Three Enhanced 16-Bit Timers with Capture, Compare, and PWM Capability.** Three enhanced 16-bit reloadable timers can be used for Timing/Counting events or for motor control operations. These timers provide a 16-bit programmable reload counter and operate in ONE-SHOT, CONTINUOUS, GATED, CAPTURE, COMPARE, CAPTURE and COMPARE, and PWM modes.

**Watch-Dog Timer (WDT) with Dedicated Internal RC Oscillator.** Watchdog Timer's internal RC oscillator continues to operate if enabled by the oscillator control register.

**Single-Pin On-Chip Debugger (OCD).** The Z16FMC Series products feature an integrated On-Chip Debugger (OCD). The OCD provides a rich set of debugging capabilities, such as reading and writing registers, programming Flash memory, setting breakpoints and executing code. The OCD uses one single-pin interface for communication with an external host.

**Twelve-Channel, 10-Bit Analog-to-Digital Converter (ADC).** The ADC converts an analog input signal to a 10-bit binary number with a time stamp that is ideal for voltage/current sampling and back-EMF sensing.

**On-Chip Analog Comparator.** The analog comparator compares the signal at an input pin with either an internal programmable reference voltage or with a signal at the second input pin. The comparator output is used either to drive a logic output pin or to generate an interrupt.

**ESPI, I2C, UARTs with LIN/IRDA.** The ESPI supports the SPI and I2S modes of operation. The I2C Master/Slave Controller operates in MASTER/SLAVE or SLAVE ONLY modes. Two full-duplex UART communication channels contain two fully-functional, high-performance infrared encoder/decoders, provide LIN protocol support, and are capable of handling asynchronous data transfers.

**Voltage Brownout (VBO) Protection.** The VBO circuit forces the device to the Reset state, when the supply voltage drops below the VBO threshold voltage (unsafe level). While the supply voltage remains below the Power-On Reset threshold voltage (VPOR), the VBO circuit holds the device in reset.

**Power-On Reset (POR).** The POR circuit monitors the digital supply voltage and holds the device in the Reset state until the digital supply voltage reaches a safe operating level.

**2.7 V to 3.6 V operating voltage.** A nominal operating voltage with a specified tolerance applied. The design voltage range to remain within the unit's operating tolerances.

**Operating Temperature.** 0°C to 70°C standard temperature range, -40°C to 105°C extended temperature range.

## Motion Detection and Control with the ZMOTION<sup>®</sup> Detection Module II

Zilog's ZMOTION<sup>®</sup> Detection Module II (ZDM II) is a complete motion detection solution ideally suited for applications that need to detect human presence. It is an excellent solution for detecting people as they approach entrances, kiosks, product displays, vending machines, appliances and advertising displays.

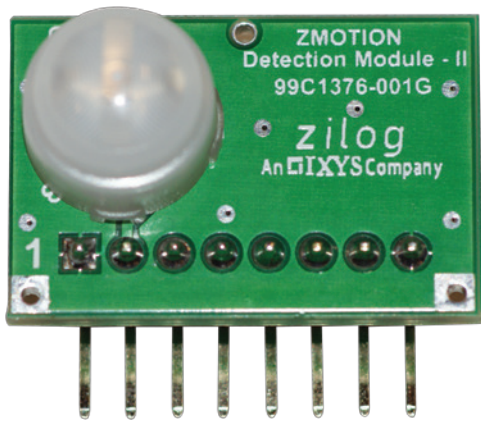

The ZMOTION<sup>®</sup> Detection Module II supports two modes of operation:

**Serial Mode.** Command, control and configuration is performed over a simple 9600bps asynchronous interface to an MCU that is already required for the application.

**Hardware Mode.** Stand-alone motion detection with analog inputs for sensitivity, 'active on-time' control and ambient light detection.

The Z8FS040 Motion Detection MCU included on the module is programmed with application software that provides these Hardware and Serial Modes of operation. This application software can be modified and replaced with your own custom application while taking full advantage of ZMOTION<sup>®</sup> technology.

### Documentation

Product Brief (PB0244)  
User Manual (UM0260)

Product Specification (PS0305)

### Reference Designs, Application Notes and Source Code

#### Reference Designs

ZMOTION<sup>®</sup> Detection Module II Reference Design (RD0026, RD0026-SC01)

Motion Sensing & LED Control with a ZMOTION/ IXYS Display (RD0003, RD0003-SC01, RD0003-SC02, RD0003-SC03)

### Application Notes

Controlling Power with the ZMOTION<sup>®</sup> Detection Module and Clare Solid State Relays (AN0319)

High Brightness LED Reference Design (AN0309, AN0309-SC01)

ZMOTION<sup>®</sup> Detection Module Application Walkthrough (AN0307, AN0307-SC01)

Power Management and Customer Sensing (AN0301, AN0301-SC01)

### ZMOTION<sup>®</sup> Detection Module II Block Diagram

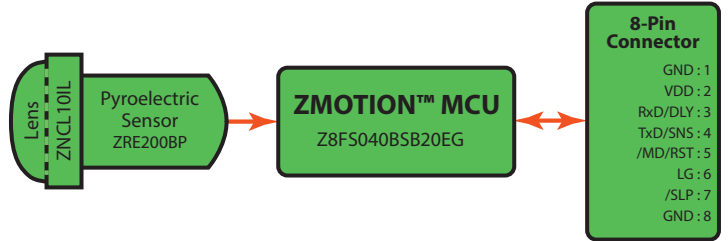

### Product Features

- Complete motion detection solution including pyroelectric sensor and clip-on lens
- Direct sensor interface and advanced software based motion detection algorithms provide superior sensitivity and stability
- Small form factor: only 25.5 mm x 16.7 mm (1" x 0.66")
- Circular 9.0 mm lens
- 8-pin interface connector with two orientations available (rightangle and straight)
- 95° detection pattern with adjustable range/sensitivity
- Simple hardware or advanced serial (UART) based configuration and interface
- Adjustable sensitivity and output activation time and support for Ambient Light Sensor input
- Serial mode includes unique Hyper Sense feature that automatically increases sensitivity after motion is detected
- Sleep Mode for low power applications
- Minimal components ensures high reliability (no electrolytic capacitors)
- Modify the application code to suite application requirements
- 2.7V to 3.6V operation from 0°C to 70°C

### Typical Detection Pattern

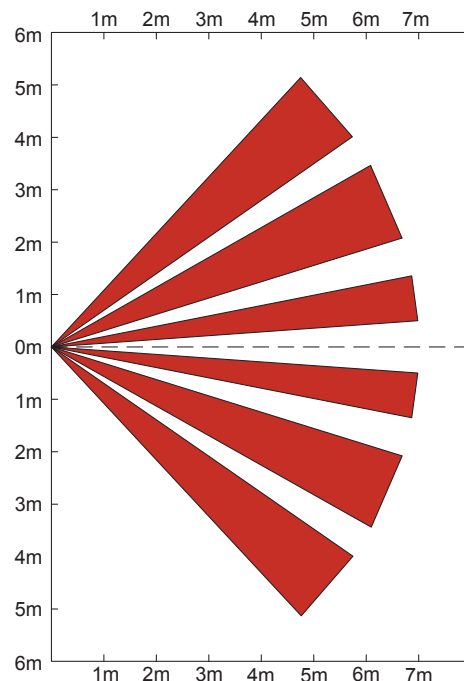

**Complete, fully functional motion detection module.** Zilog's Detection Module is a complete, compact and highperformance product specifically designed for the rapid development and deployment of products requiring control based on infrared motion detection. The module includes the pyroelectric sensor, a Fresnel lens and the Z8FS040 MCU, which is preprogrammed with motion detection software and does not require any external temperature compensation. The software detection algorithms deliver a significant performance improvement over traditional PIRbased solutions.

**Small Form Factor with standard header.** A form factor of 1" x 0.66" (25.5 mm x 16.7 mm) with a standard 8-pin header allows for stand-alone operation or for mounting onto another PCB.

**Standard and Extended Range Support.** The typical detection pattern covers a 95° cone up to 3 m (Standard) or 5m (Extended). Zilog's proprietary algorithms provide a high level of stability at these extended ranges.

**Serial and Hardware Interface.** Configuration and control can be managed via analog and digital inputs/outputs or via serial communication with the Universal Asynchronous Receiver/Transmitter (UART), all using the 8-pin interface to the module.

**Sensitivity and Delay Control.** Sensitivity and delay can be controlled by either the serial or hardware interface, allowing for complete control of the environment to ensure proper detection in your application.

**Ambient Light Adjustment.** Allows adjustment for ambient light, typically via an external photocell.

**SLEEP mode for lower-power applications.** The module can be placed into SLEEP mode to conserve power. While in SLEEP mode, the module will draw only 450 µA of current, but it will not detect any motion.

**Single Digital Output.** A single digital output for motion detection that can be used in stand-alone applications.

**High MTBF.** The module is implemented with a small number of components and algorithms that have been tested in numerous applications to ensure highest possible quality and reliability.

**Memory space for application code.** Allows the user to create application-specific code in the module when application requirements demand flexibility.

**Complete ZDS II development system available.** The development kit includes a base board in which the ZMOTION® Detection Module II is plugged, a prototyping area with potentiometers, LEDs, a CDS photocell that enables you to add your own custom application hardware, and a serial interface to the ZDS II USB Smart Cable to allow development and debugging of custom application software.



## ZMOTION Detection Module II (ZDM II) A Complete Motion Detection Solution





ZDM II with Right-Angle Connector (ZEPIR0BAS02MODG)



ZDM II with Straight Connector (ZEPIR0BBS02MODG)

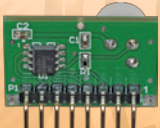

Back of Right-Angle Connector

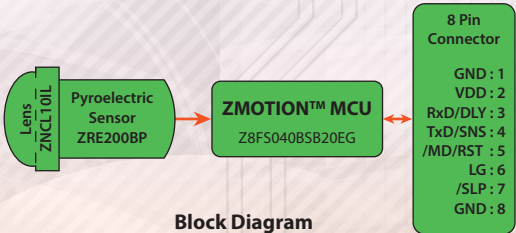

**Block Diagram**

**KEY FEATURES:**

- Includes pyroelectric sensor and clip-on lens
- Direct sensor interface and advanced software-based motion detection algorithms
- Small form factor: only 25.5 mm x 16.7 mm (1" x 0.66")
- Circular 9.0 mm lens
- 8-pin interface connector with two orientation options available (right-angle and straight)
- 95-degree detection pattern with adjustable range/sensitivity
- Simple hardware or advanced serial (UART)-based configuration and interface
- Sleep Mode for low power applications
- Minimal components ensures high reliability
- 2.7V to 3.6V operation from 0°C to 70°C

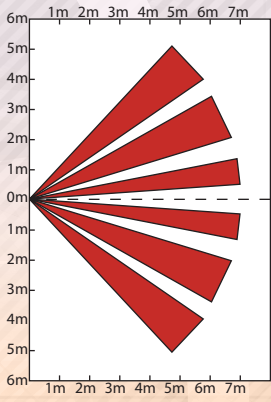

**Detection Pattern**

**APPLICATIONS:**

- Unattended Vending and Kiosks
- Display Systems
- Home Appliances
- Lighting Control
- Power Management
- HVAC
- Access Control
- General-Purpose Proximity Sensing

Zilog's ZMOTION Detection Module II Evaluation Kit (ZEPIR000103KITG) makes it quick and easy to integrate ZDM II into your own custom applications.

To learn more about our ZMOTION products, please visit [www.zilog.com/ZMOTION](http://www.zilog.com/ZMOTION).



Design With Freedom



## ZMOTION™ Occupancy Detection Solution with ZMOTION MCU and Software

If you already have your lens and pyroelectric sensor and simply need the control and flexibility of an MCU and software with an API to access and fine-tune your application, consider Zilog's dedicated MCU and optimized software solution to complete your development. With integrated motion detection algorithms and an API to monitor and control them, you can create your own application software knowing that the motion detection portion of the design is already in place.



The motion detection algorithms comprise the PIR engine and run in the background of the MCU while control and status of the engine is accessed through a software Application Programming Interface (API). In effect, you can create your own application-specific software while taking advantage of PIR motion-detection technology. For example, the ZMOTION MCU includes a comparator with internal programmable voltage reference for zero-cross detection, a 10-bit Sigma/Delta ADC for ambient light detection or battery monitoring/charging, a UART for serial communications and two 16-bit timers with input capture/compare and PWM outputs.

### Reference Designs, Application Notes and Source Code

#### Reference Designs

Motion Sensing & LED Control with a ZMOTION/ IXYS Display (RD0003, RD0003-SC01, RD0003-SC02, RD0003-SC03)

#### Application Notes

ZMOTION Detection Module Application Walkthrough (AN0307, AN0307-SC01)

High Brightness LED Reference Design (AN0309, AN0309-SC01)

### ZMOTION MCU Block Diagram

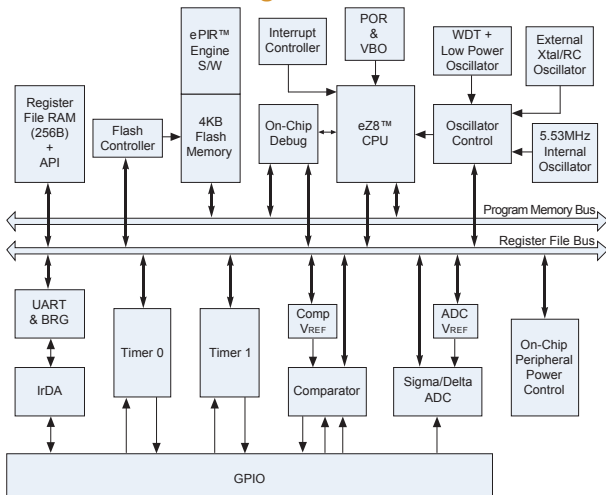

Used in lighting controls, access control, display systems and general-purpose proximity-sensing applications, the ZMOTION MCU with optimized software solution provides an easy way to add energy management capability to various applications such as vending machines and appliances.

### Product Features and Benefits

- Includes preprogrammed ZMOTION motion detection algorithms
- No need to develop complex motion detection software
- Create a custom design and form factor while taking advantage of ZMOTION Detection and Control Technology
- The ZMOTION PIR Engine runs in the background of the MCU while control/status of the Engine is accessible through a software API
- Example hardware and software designs are available with the ZMOTION Development Kit
- 4KB Flash program memory available for custom applications
- The ZMOTION MCU can perform other tasks specific to the application
- Optimized detection performance and reliability

### Documentation

Product Brief (PB0225)  
 User Manual (UM0230)

Product Specification (PS0285)

### Other ZMOTION Products

**ZMOTION Detection Module.** A complete board-level module that provides a fully-functioning, small-form-factor motion detection solution that can be integrated into your product.

**ZMOTION Detection and Control Bundle.** The ZMOTION MCU bundled with a selection of lenses and pyroelectric sensors, plus API settings for optimal lens performance.

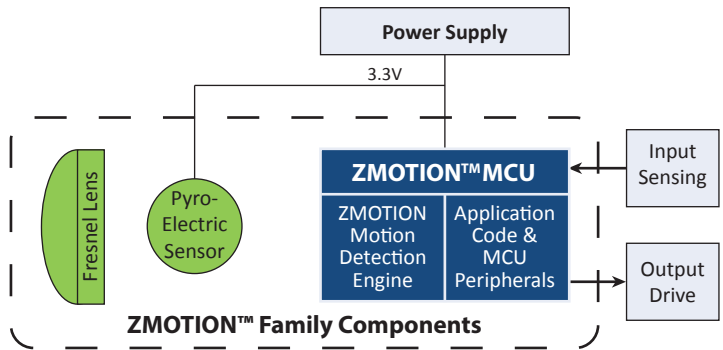

**Includes preprogrammed ZMOTION motion detection algorithms.** Zilog's ZMOTION MCU combines the programmability and rich peripheral set of the Flash-based Z8FS040 MCU with built-in software-based motion detection algorithms. These motion detection algorithms comprise the PIR engine and run in the background of the MCU while control and status of the engine is accessed through a software API.

**No need to develop complex motion detection software.** With Zilog's ZMOTION Occupancy Detection solution, the system bill of materials is significantly reduced. The pyroelectric sensor is directly interfaced to the MCU eliminating external op-amps, electrolytic capacitors, and other components used in traditional designs. The new statistical processing algorithms provided by the PIR motion-detection engine also eliminate the need for a discrete temperature compensation circuit. This all leads to a simpler and smaller circuit design, providing better reliability, sensitivity, and stability than traditional designs.

**4KB Flash Memory space for application code.** Allows the user to create application-specific code in the module when application requirements demand flexibility. The ZMOTION MCU is part of the ZMOTION family of products that also includes lenses, pyroelectric sensors and board level modules all optimized to the application.

**Complete ZDS II development system available.** The development kit includes a base board in which the ZMOTION Detection Module is plugged, a prototyping area with potentiometers, LEDs, a CDS photocell that enables you to add your own custom application hardware, and a serial interface to the ZDS II USB Smart Cable to allow development and debugging of custom application software.



## Zilog's World of Sensors (WoS) Design Board

### Includes Seven Different Sensors

### Sensing Technology You Can Easily Experiment With



The **World of Sensors Design Board** ships with a USB cable (A to Mini-B Male); \***Mini-Z modules are sold separately.**



**(Z16F28WS100ZRDG)**

Start designing right out of the box with the comprehensive **World of Sensors Design Kit.**



**(Z16F28WS100KITG)**

**KEY FEATURES:**

- Seven Sensor Options on Different Peripherals
  - Accelerometer
  - Ambient Light Sensor
  - Humidity
  - Microphone
  - Pressure Sensor
  - Proximity Sensor
  - Temperature Sensor
- Serial LCD display
- USB serial communications (no serial cables required)
- Operated by battery or external power
- Compatible with Zilog's series of Mini-Z modules, as well as other vendors' basic stamp modules

Designed to provide engineers, students and enthusiasts a simple-to-use platform for developing prototypes and projects that will incorporate multiple sensors.

\*Zilog's series of Mini-Z 28-pin modules includes the Mini-Z ZNEO Module, the Mini-Z WLAN Module, and the Mini-Z Z-PAN Module.

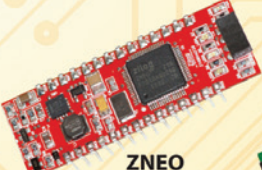

**ZNEO**



**WLAN**

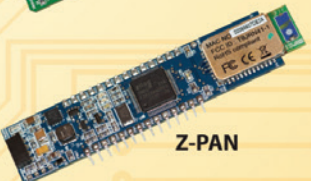

**Z-PAN**

**APPLICATIONS:**

- Weather stations
- Car alarms
- Wireless monitors
- Robotic sweepers
- Remote control applications

To purchase the World of Sensors Design Board or Design Kit, please visit our Zilog Store at [www.zilog.com/Store](http://www.zilog.com/Store).



Design With Freedom

## ZMOTION™ 8-Pin Occupancy Detection Solution with Lens and Pyroelectric Sensor Selection Options

If you don't have your own lenses and pyros, you can optimize the performance of your product by choosing a lens and pyro to match your application. Zilog combines the ZMOTION MCU in an 8-pin package and integrated motion detection algorithms with a selection of lenses and PIR sensors to fit a wide range of applications. However, if your application requires more analog input and/or additional sensing options than an 8-pin package will provide, Zilog also offers a 20-pin option.

Zilog's family of lenses spans 360-degree ceiling, 180-degree wall mount, 15-meter long range and 5-meter short range. API settings are provided to match the PIR engine operation to each of our lens and PIR sensor combinations.



PIR motion-detection technology provides a dramatic improvement in both sensitivity and stability over traditional designs and is scalable to many market segments including Lighting Control, HVAC, Access Control, Vending, Display, Proximity, Power Management, Occupancy Sensing, and many others.

The ZMOTION 8-Pin MCU is programmed with application software that offers hardware and serial modes of operation. It is designed to be modified for your own custom application while taking full advantage of ZMOTION technology.

### Product Features and Benefits

- Wall, ceiling, high ceiling, corner wall and long range mounting options with Fresnel and Nicera lenses
- Circular and rectangular floor pattern options
- Basic dual, premium dual and quad element pyroelectric sensor options
- Lens selection options target lighting control, HVAC, meeting rooms, appliances, vending power management and kiosk/display control applications
- Optimize the performance of your product by choosing a lens that closely matches your application
- Includes preprogrammed ZMOTION detection algorithms
- API settings are provided to match the ZMOTION Engine operation to each of the lens and PIR sensor combinations provided

### Reference Designs, Application Notes and Source Code

#### Reference Designs

Motion Sensing & LED Control with a ZMOTION/ IXYS Display (RD0003, RD0003-SC01, RD0003-SC02, RD0003-SC03)

#### Application Notes

ZMOTION Detection Module Application Walkthrough (AN0307, AN0307-SC01)

High Brightness LED Reference Design (AN0309, AN0309-SC01)

### ZMOTION Occupancy Detection Block Diagram

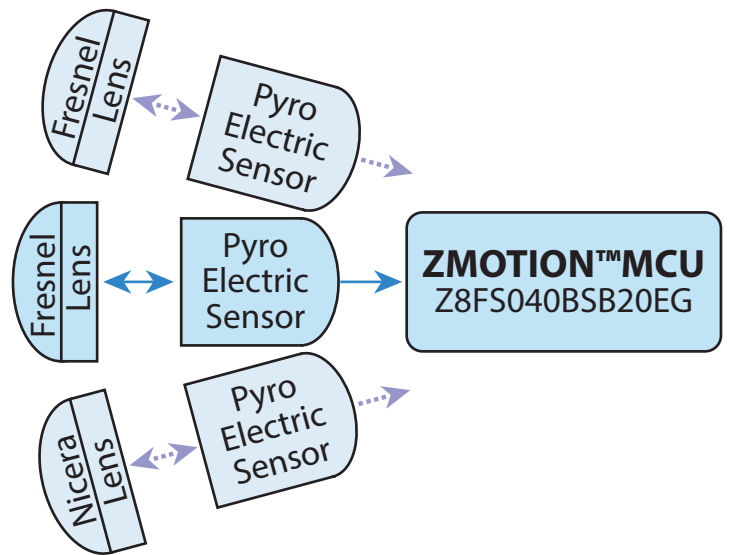

### Part Numbers

Z8FS040BSB20EG  
 ZMOTIONL100ZCOG

### Description

ZMOTION 8-Pin MCU  
 ZMOTION Detection and Control Development Kit



### Documentation

Product Brief (PB0225)  
 User Manual (UM0230)

Product Specification (PS0285)  
 White Paper (WP0018)



**A selection of matched lens and pyroelectric sensors available to meet a variety of applications.** Optimized configuration parameters for the ZMOTION 8-Pin MCU are provided for each lens/sensor combination ensuring the best possible performance while significantly reducing development risk and minimizing time to market.

**Wall, ceiling, high ceiling, corner wall and long range mounting options.** Optimize the performance of your product by choosing a lens that closely matches your application. Use your own or select from our family of lenses spanning 360-degree ceiling, 180-degree wall mount, 15-meter long range, and 5-meter short range.

**Includes preprogrammed ZMOTION detection algorithms.** Zilog's ZMOTION 8-Pin MCU combines the programmability and rich peripheral set of the Flash-based Z8FS040B MCU with built-in software-based motion detection algorithms. These motion detection algorithms comprise the PIR engine and run in the background of the MCU while control and status of the engine is accessed through a software API.

**API settings.** Optimized API settings are provided for each lens and pyroelectric sensor combination.

**Standard and Extended Range Support.** An API register setting allows the user to set the sensitivity of the extended detector to detect slower, faster, or more subtle motion.

**SLEEP mode for lower-power applications.** User-controlled modes. The API register settings allow the user to implement and adjust sensitivity control, range control, directionality detection, hypersense, and low-power modes..

**High MTBF.** The module is implemented with a small number of components and algorithms that have been tested in numerous applications to ensure highest possible quality and reliability.

**Reduced Bill of Materials.** Because the pyroelectric sensor is directly interfaced to the MCU, external op amps, electrolytic capacitors and other components are eliminated. The enhanced PIR motion detection engine also eliminates the need for a discrete temperature compensation circuit.

**Complete ZDS II development system available.** The development kit includes a ZMOTION Development Board, mini-USB serial cable, a selection of lenses and pyroelectric sensors, lens holders, power supply, and a ZDSII USB Smart Cable to allow development and debugging of custom application software.

# High Power Digital Inrush Current Controller

(Based on Zilog's Z8F3281 Microcontroller)

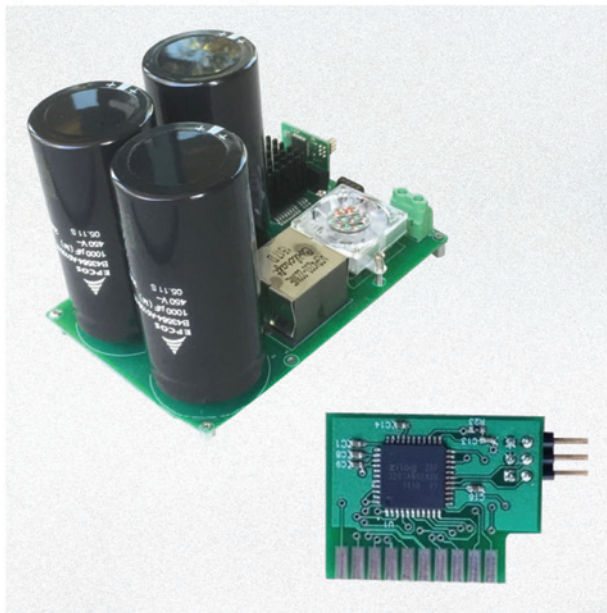

## FEATURES:

- Input voltage ranging from 80V to 240VRMS
- Steady load current up to 10A
- Programmable overload protection
- Power good status signal high endurance
- Not sensitive to power outage or brownout
- Not sensitive to ambient temperature variations
- Voltage ripples 12% 10A load current and output capacitance of 3000 $\mu$ F

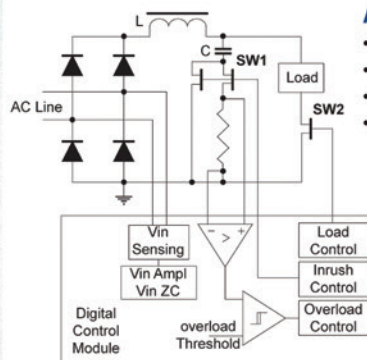

## APPLICATIONS:

- High power AC-DC rectifiers
- High power AC-DC PFC converters
- AC-DC power supplies for data centers
- High power motor drivers

**IXYS POWER**  
Efficiency Through Technology

EUROPE  
IXYS GmbH  
marcom@ixys.de  
+49 (0) 6206-503-249

USA  
IXYS Power  
sales@ixys.com  
+1 408-457-9042

ASIA  
IXYS Taiwan/IXYS Korea  
sales@ixys.com.tw  
sales@ixyskorea.com



www.ixys.com



Embedded in Life

An IXYS Company

## ZMOTION™ 20-Pin Occupancy Detection Solution with Lens and Pyroelectric Sensor Selection Options

If you don't have your own lenses and pyros but need more analog input and/or additional sensing options than an 8-pin package will provide, Zilog offers the 20-pin ZMOTION MCU. Like the 8-pin version, you can optimize the performance of your product by choosing a lens and pyro to match your application. Zilog combines the ZMOTION MCU and integrated motion detection algorithms with a selection of lenses and PIR sensors to fit a wide range of applications. Zilog's family of lenses spans 360-degree ceiling, 180-degree wall mount, 15-meter long range and 5-meter short range. API settings are provided to match the PIR engine operation to each of our lens and PIR sensor combinations.



PIR motion-detection technology provides a dramatic improvement in both sensitivity and stability over traditional designs and is scalable to many market segments including Lighting Control, HVAC, Access Control, Vending, Display, Proximity, Power Management, Occupancy Sensing, and many others.

The ZMOTION 20-Pin MCU is programmed with application software that offers hardware and serial modes of operation. It is designed to be modified for your own custom application while taking full advantage of ZMOTION technology.

### Product Features and Benefits

- Wall, ceiling, high ceiling, corner wall and long range mounting options with Fresnel and Nicera lenses
- Circular and rectangular floor pattern options
- Basic dual, premium dual & quad element pyroelectric sensor options
- Lens selection options target lighting control, HVAC, meeting rooms, appliances, vending power management and kiosk/display control applications
- Optimize the performance of your product by choosing a lens that closely matches your application
- Includes preprogrammed ZMOTION detection algorithms
- API settings are provided to match the ZMOTION Engine operation to each of the lens and PIR sensor combinations provided

### Reference Designs, Application Notes and Source Code

#### Reference Designs

Motion Sensing & LED Control with a ZMOTION/ IXYS Display (RD0003, RD0003-SC01, RD0003-SC02, RD0003-SC03)

#### Application Notes

ZMOTION Detection Module Application Walkthrough (AN0307, AN0307-SC01)

High Brightness LED Reference Design (AN0309, AN0309-SC01)

### ZMOTION Occupancy Detection Block Diagram

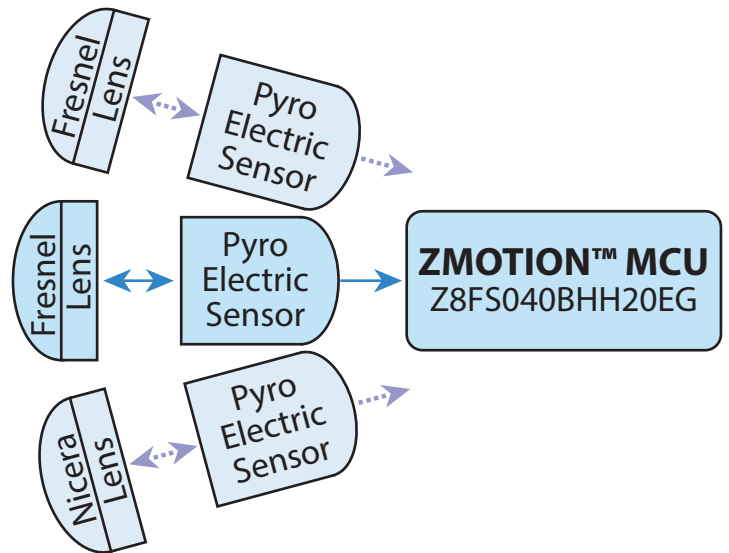

### Part Numbers

Z8FS040BHH20EG  
ZMOTIONL200ZCOG

### Description

ZMOTION 20-Pin MCU  
ZMOTION 20-Pin Detection and Control Development Kit



### Documentation

Product Brief (PB0225)  
User Manual (UM0239)

Product Specification (PS0285)  
White Paper (WP0018)

**A selection of matched lens and pyroelectric sensors available to meet a variety of applications.** Optimized configuration parameters for the ZMOTION 8-Pin MCU are provided for each lens/sensor combination ensuring the best possible performance while significantly reducing development risk and minimizing time to market.

**Wall, ceiling, high ceiling, corner wall and long range mounting options.** Optimize the performance of your product by choosing a lens that closely matches your application. Use your own or select from our family of lenses spanning 360-degree ceiling, 180-degree wall mount, 15-meter long range, and 5-meter short range.

**Includes preprogrammed ZMOTION detection algorithms.** Zilog's ZMOTION 8-Pin MCU combines the programmability and rich peripheral set of the Flash-based Z8F504 MCU with built-in software-based motion detection algorithms. These motion detection algorithms comprise the PIR engine and run in the background of the MCU while control and status of the engine is accessed through a software API.

**API settings.** Optimized API settings are provided for each lens and pyroelectric sensor combination.

**Standard and Extended Range Support.** An API register setting allows the user to set the sensitivity of the extended detector to detect slower, faster, or more subtle motion.

**SLEEP mode for lower-power applications.** User-controlled modes. The API register settings allow the user to implement and adjust sensitivity control, range control, directionality detection, hypersense, and low-power modes..

**High MTBF.** The module is implemented with a small number of components and algorithms that have been tested in numerous applications to ensure highest possible quality and reliability.

**Reduced Bill of Materials.** Because the pyroelectric sensor is directly interfaced to the MCU, external op amps, electrolytic capacitors and other components are eliminated. The enhanced PIR motion detection engine also eliminates the need for a discrete temperature compensation circuit.

**Complete ZDS II development system available.** The development kit includes a ZMOTION Development Board, mini-USB serial cable, a selection of lenses and pyroelectric sensors, lens holders, power supply, and a ZDSII USB Smart Cable to allow development and debugging of custom application software.



# Be Wireless with ZigBee

Connect with **FREEDOM** and **FLEXIBILITY** at your fingertips in a **CONVERGING** world

**MG2470** is a true 2.4GHz system-on-chip (SoC) designed for low-power, low-cost applications based on the industry standards such as IEEE802.15.4 and RF4CE. The MG2470 uses the ISM band of 2.4~2.48GHz. In addition to the standard data-rate specified in IEEE802.15.4, various data-rate modes (31.25kbps~1Mbps) with channel coding are supported.

The **MG2470** involves advanced RF transceiver, baseband PHY, MAC with AES-128 engine, enhanced 8-bit 8051 MCU with internal 64-KB flash memory and 6-KB SRAM, and application-specific peripherals.



Software Component  
Device-Programmer MD



Hardware Component

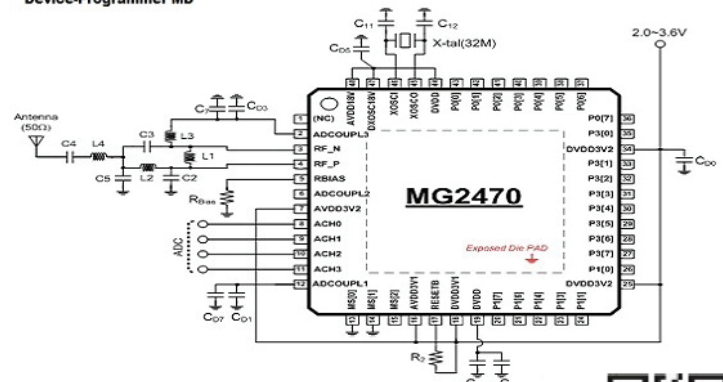
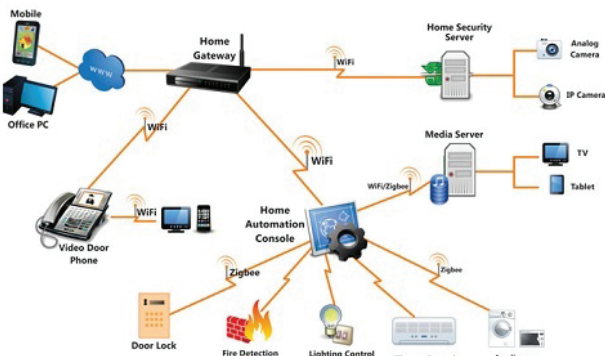

For more information, visit [www.zilog.com](http://www.zilog.com)





## ZMOTION™ Intrusion Detection Solution with Lens and Pyroelectric Sensor Selection Options

Zilog's ZMOTION Intrusion Detection Solution provides a dramatic improvement in both sensitivity and stability over traditional security-related motion detection designs. Like our other ZMOTION products, the Intrusion Detection Solution is an integrated and flexible solution for Passive Infrared (PIR)-based motion detection applications and includes a high-performance microcontroller with integrated motion-detection algorithms, plus it includes a selection of lenses and PIR sensors to fit a wide range of intrusion detection and security applications. With integrated functions such as White Light Detection and Pet Immunity, the ZMOTION Intrusion Detection Solution is the ideal solution for security applications in which highly stable intrusion detection capability is vital.



The ZMOTION Intrusion Detection Solution, based on Zilog's Z8FS021 MCU, combines the programmability and rich peripheral set of our Z8 Encore! XP family of In-Circuit Programmable Flash MCUs with built-in motion detection software algorithms to provide the functions necessary for PIR motion detection applications. These algorithms comprise the PIR Engine and run in the background while control and status of the Engine is accessed through a software Application Programmer Interface (API). These APIs allow designers to create their own application-specific software while taking advantage of Zilog's ZMOTION Motion Detection Technology. Additional API settings are provided to match PIR Engine operation to each lens and pyroelectric sensor combination.

### Reference Designs, Application Notes and Source Code

#### Reference Designs

Motion Sensing & LED Control with a ZMOTION/ IXYS Display (RD0003, RD0003-SC01, RD0003-SC02, RD0003-SC03)

#### Application Notes

ZMOTION Detection Module Application Walkthrough (AN0307, AN0307-SC01)

High Brightness LED Reference Design (AN0309, AN0309-SC01)

### Documentation

Product Brief (PB0230)  
 User Manual (UM0233)

Product Specification (PS0288)

## ZMOTION Intrusion Detection Block Diagram

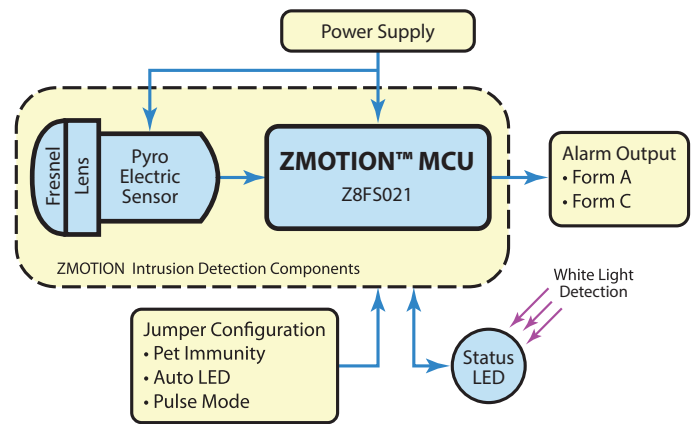

## Product Features and Benefits

- Accurate frequency discrimination and programmable pet immunity
- White light detection using status LED reduces system cost (eliminates CDS photocell)
- Wall, corner wall and long range mounting options with Fresnel and Nicera lenses
- Rectangular floor pattern options
- Lens selection options target security and intrusion detection applications for wide area, long corridors and warehouse settings
- Optimize the performance of your product by choosing a lens that closely matches your application
- Includes preprogrammed ZMOTION detection algorithms
- API settings are provided to match the ZMOTION Engine operation to each of the lens and PIR sensor combinations provided

## Part Numbers

## Description

Part Numbers	Description
Z8FS021AHH20EG	ZMOTION MCU ZMOTION Intrusion Detection Development Kit

## Other ZMOTION Development Options

**ZMOTION Detection Module.** A complete board-level module that provides a fully-functioning, small-form-factor motion detection solution that can be integrated into your product.

**ZMOTION Detection and Control.** Zilog also offers a bundled ZMOTION solution for non-security-related applications with a selection of lenses and pyroelectric sensors, plus API settings for optimal lens performance.



**A selection of matched lens and pyroelectric sensors available to meet a variety of applications.** Optimized configuration parameters for the ZMOTION MCU are provided for each lens/sensor combination ensuring the best possible performance while significantly reducing development risk and minimizing time to market.

**Adjustable PIR Sensitivity.** The sensitivity of the PIR Engine can be adjusted to target slow, fast, and subtle motion while maintaining stability to avoid false detections.

**Wall, corner wall and long range mounting options.** Optimize the performance of your product by choosing a lens that closely matches your application. Use your own or select from our family of lenses spanning 90-degree wall mount, 30- meter long range, and 7-meter height range.

**Includes preprogrammed ZMOTION detection algorithms.** Zilog's ZMOTION MCU combines the programmability and rich peripheral set of the Flash-based Z8FS021 MCU with built-in software-based motion detection algorithms. These motion detection algorithms comprise the PIR engine and run in the background of the MCU while control and status of the engine is accessed through a software API.

**API settings.** Provided to match the ZMOTION Engine operation to each of the lens and PIR sensor combinations.

**Complete ZDS II development system available.** The ZMOTION Intrusion Detection Development Kit includes a base board in which the ZMOTION Intrusion Detection MCU is plugged, a prototyping area with potentiometers, LEDs, a CDS photocell that enables you to add your own custom application hardware, and a serial interface to the ZDS II USB Smart Cable to allow development and debugging of custom application software.



## Go with the Best in Motion Detection Technology

### Zilog's ZMOTION® PIR-Based Motion Detection Solutions



#### ZMOTION Intrusion Detection Block Diagram

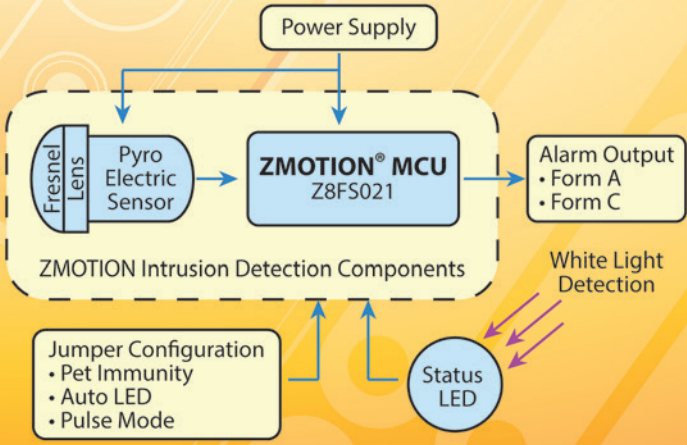

**Intrusion Applications Z8FS021**

- Wide-area intrusion detector
- Corridor, curtain & vertical barrier motion detectors
- Dual mode lighting/intrusion detector
- Secure access control
- Stand-alone alarm systems

**Occupancy Applications Z8FS040**

- Lighting control
- Access control
- Customer sensing
- HVAC control
- Occupancy sensing
- Vending applications
- Automatic displays
- Proximity
- Power management

**ZMOTION Development Kits**

ZMOTIONL100ZCOG	ZMOTIONL200ZCOG	ZMOTIONS200ZCOG
ZMOTION Detection and Control Development Kit	ZMOTION 20-pin Detection and Control Development Kit	ZMOTION Intrusion Detection Development Kit

**Zilog offers a wide selection of lens and pyroelectric sensor bundled options to fit your application needs.**

For more information or documentation about Zilog's ZMOTION products, please visit [www.zilog.com/ZMOTION](http://www.zilog.com/ZMOTION).

## Ethernet Connectivity Solutions

### eZ80AcclaimPlus!™ Ethernet Modules

Zilog's eZ80AcclaimPlus! Ethernet Module (eZ80F917150MODG) and the eZ80F91 Mini Enet Module, (eZ80F916005MODG) are compact, high-performance devices specially designed for the rapid development and deployment of embedded systems requiring control and internet/intranet connectivity.

These expandable modules are powered by Zilog's power-efficient, optimized-pipeline architecture eZ80F91 MCU, a member of Zilog's eZ80AcclaimPlus!™ family. The eZ80F91 MCU is a high-speed, single-cycle instruction-fetch microcontroller that operates with a clock speed of 50 MHz. It can also operate in Z80®-compatible addressing mode (64 KB) or full 24-bit addressing mode (16 MB).

The rich peripheral set of these eZ80AcclaimPlus!™ Ethernet Modules make them suitable for a variety of applications, including industrial control, communication, security, automation, point-of-sale terminals, and embedded networking applications.

### Zilog TCP/IP Protocol Stack (ZTP)

ZTP is a preemptive, multi-tasking RTOS integrated with an RFC compliant TCP/IP protocol software stack optimized for embedded eZ80F91 applications. The modular design of ZTP enables the user to include only the library objects required by the application minimizing the memory footprint.

This S/W is provided in object form free of charge and without royalties or license fees to Zilog customers.

- ZTP-Supported Core Protocols (IPv4, TCP, UDP, ARP, RARP, ICMP, IGMP, PPP, DHCP/BOOTP, Ethernet, SSL Server)

### Higher-Level TCP/IP Services

HTTP/HTTPS server, TFTP server, SNMP agent, TELNET client/server, SMTP client, DNS client, TIMEP client and FTP client/server (includes file system).

### Application Notes & Source Code Files

Implementing Mixed Memory Modes on the eZ80 CPU (AN0339, AN0339-SC01)

Calling Assembly from C & Vice Versa: ZDSII – eZ80Acclaim! (AN0333)

ZDS II for eZ80Acclaim!: Explicit Code Memory Placement in C (AN0332, AN0332-SC01)

AJAX Web Page Control and Monitoring via the Internet Using the Zilog eZ80AcclaimPlus Embedded Web Server (AN0305, AN0305-SC01)

Data Transfer Between a Serial Link and a TCP/IP Link Using the eZ80F91 MCU (AN0219, AN0219-SC01)

Ethernet Frame Transmission Using the eZ80F915050 Module (AN0212, AN0212-SC01)

Interfacing an HTML Form to the eZ80F91 MCU (AN0208, AN0208-SC01)

A Web Page Interface for the eZ80F91 MCU Using Java (AN0178, AN0178-SC01)

A Serial-to-TCP Gateway for eZ80AcclaimPlus!™ Connectivity ASSP (AN0160, AN0160-SC01, AN0160-SC08)

## Documentation

Product Brief (PB0220)

Product Specification (PS0306)

## eZ80AcclaimPlus! Ethernet Module Block Diagram

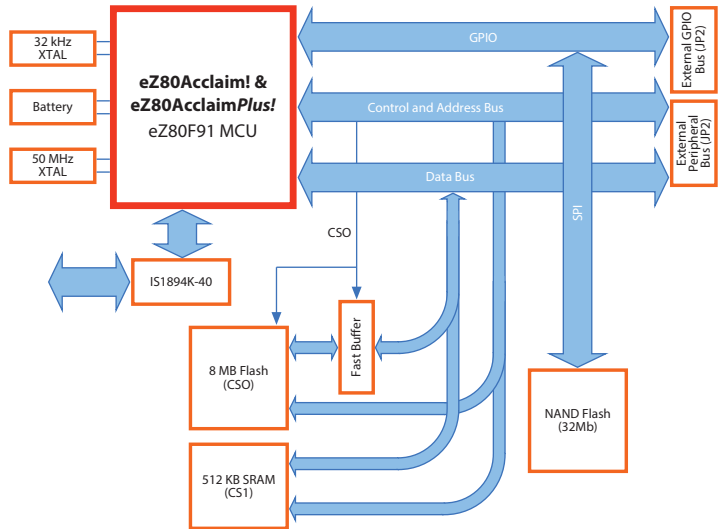

## Part Numbers

### eZ80F917150MODG

- 256KB + 8MB Flash
- 16KB + 512KB RAM
- 2 60-pin dual in-line interface connectors
- 79mm x 63mm (3.1" x 2.5")

### eZ80F916005MODG

- 256KB Flash
- 16KB + 128KB RAM
- 2 56-pin dual in-line interface connectors
- 51mm x 48mm (2.0" x 1.9")

## eZ80AcclaimPlus! Features and Benefits

- 50MHz High Performance eZ80® CPU Core
- 256KB Flash Program Memory internal to the eZ80F91
- 8MB additional Flash memory on eZ80F917150MODG
- 512KB SRAM: eZ80F917150MODG
- 128KB SRAM: eZ80F916005MODG
- Power management features supporting Sleep, Halt, and peripheral power-down controls
- 32-bit GPIO
- Four 16-bit Counter/Timers with pre-scalers and direct input/output drive
- Two independent UARTs with multi-drop mode
- SPI and I2C ports
- Watch-Dog Timer with selectable clock inputs
- Real-time clock with 32KHz oscillator support
- RJ-45 connector supporting 10/100BaseT Ethernet
- 56 pin dual in-line interface connector (eZ80F916005MODG)
- 60 pin dual in-line interface connector (eZ80F917150MODG)
- Full external processor bus, I/Os and peripherals available on interface connectors for system expansion
- RFC Compliant TCP/IP stack and RTOS



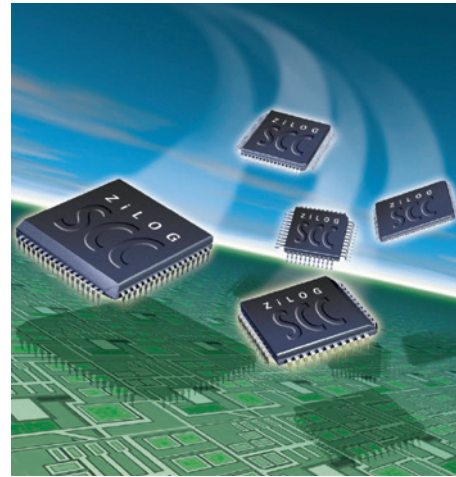

## Multi Protocol Serial Communications

### Zilog's Enhanced Serial Communications Controllers: Z85230/Z80230/Z8523L/Z85233

Zilog's Enhanced Serial Communication Controllers (ESCCs) are dual- and single-channel multiprotocol serial communications peripherals that are pin- and software-compatible members of Zilog's SCC family.

These ESCC controllers provide support for multiple asynchronous formats, synchronous/isochronous formats, byte-oriented synchronous protocols such as MONOSYNC and BISYNC, and bit-oriented synchronous protocols such as HDLC/SDLC and external sync.

For HDLC/SDLC communications applications, Zilog's ESCC controllers provide support up to the frame level to reduce the burden on the host CPU. This support includes automatic opening and closing flag transmission, automatic CRC generation, error checking and an SDLC Frame Status FIFO to support DMA-based applications.

An integrated Digital Phase Locked Loop can be programmed to recover the clock from NRZI-, FM0-, FM1- and Manchester-encoded data.

To reduce processor interrupt overhead, the ESCC provides an 8-byte receive FIFO and 4-byte transmit FIFO and can be used in polled interrupts of DMA-driven applications.

For products requiring asynchronous communications, the ESCC supports data formats of 5 to 8 bits per character and can use 1X, 16X, 32X or 64X clock modes. All error checking and break generation/ detection is handled automatically.

The Z85230, Z80230 are 5V dual-channel devices. The Z8523L is a dual-channel 3V device, and the Z85233 (EMSCC) is a single-channel device that provides a smaller 44-pin PQFP footprint.

#### Application Notes

Boost your System Performance Using the Zilog ESCC Controller (AN0300)  
 The Zilog Datacom Family with the 80186 CPU (AN0097)

#### Documentation

Product Brief (PB0004)	Z80C30/Z85C30/Z80230/Z85230/
Z85233 Product Specification	Z85233 SCC/ESCC User Manual
(DC4058)	(UM0109)
Z80230/Z85230/Z8523L Product	
Specification (PS0053)	

#### ESCC Features and Benefits

- Multiple protocol support: Asynchronous, Mono-Sync, Bi-Sync, External Sync, Isosynchronous and HDLC/SDLC
- Multiple encoding modes: NRZ, NRZI, FM0, FM1 and Manchester
- 4-Byte Transmit FIFO
- 8-Byte Receive FIFO
- One or two independent full-duplex channels with separate baud rate generator (BRG) and a digital phase locked loop (DPLL) for each channel
- Flexible clocking scheme provides programmable DTE/DCE operation
- Up to 5 Mbps data rate
- 5V and 3V versions available
- CRC-16 or CRC-CCITT error checking and generation
- Pin-compatible with the industry-standard SCC
- Asynchronous capabilities:
  - 5, 6, 7 or 8 bits/character
  - 1, 1.5 or 2 stop bits
  - Odd or Even parity
  - Parity, Overrun and Framing Error detection
- Character-oriented synchronous capabilities:
  - Internal or external synchronization
  - 1 or 2 SYNC characters (6 or 8 bits/character)
  - Cyclic redundancy check (CRC-16, CRC-CCITT) generation/ detection
- SDLC/HDLC capabilities:
  - Automatic zero insertion and detection
  - Automatic flag insertion between messages
  - Address field recognition for loop mode
  - CRC generation/detection

#### ESCC Block Diagram

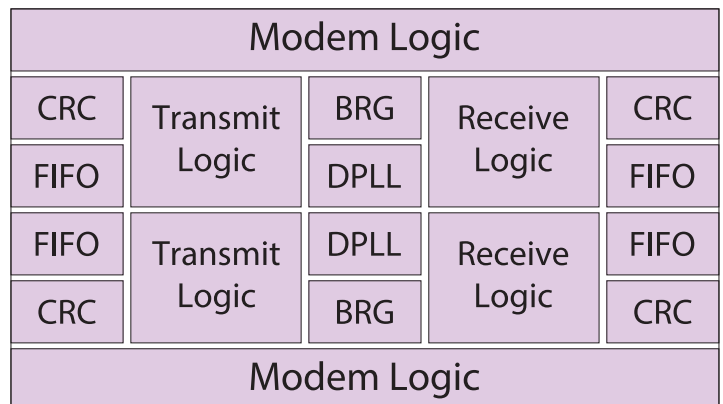



Embedded in Life  
An IXYS Company



## Low Voltage and Low Power Solutions

### Zilog's Z8 Encore! XP® F1680 Series Microcontrollers

Zilog's Z8 Encore! XP® Z8F1680 Series of Flash Microcontrollers are ideal for Low Voltage and Low Power Applications. The 1.8V to 3.6V operating range provides optimal operation from two 1.5V battery cells.

For common low power applications in which the Microcontroller (MCU) is normally in STOP Mode and periodically wakes up to determine if any actions must be taken, the Z8F1680 series provides low Stop mode current and multiple wake up methods. The Watch Dog Timer (WDT), General Purpose I/Os (GPIO), Comparator and dedicated 32-KHz timer can all be used to wake the device from Stop mode. Additionally, 1 KB of the devices RAM can be assigned as Low Power Program RAM for execution, so power is conserved even in Active (Run) modes.

Wake up time from Stop mode is 6  $\mu$ S (maximum, worst case, extended temperature), so very little power is wasted as the device comes out of Stop mode.

The 10-bit SAR ADC combined with the 4-channel 16-bit PWM timer array provides support for multi-cell battery charging applications and multi-phase motor control.

By taking advantage of the on-chip temperature sensor, Op Amp, ADC, and independent programmability of each PWM channel, this timer array also becomes an ideal RGBW LED controller.

As part of the Z8 Encore! XP® family, the Z8F1680 series is pin for pin compatible with Z8F082A, Z8F0830, and Z8F083A series, features a single-pin, on-chip debugger (OCD), and is supported by Zilog Developer Studio (ZDS-II) Integrated Development Environment.

With its extended, intelligent peripheral set and significant power savings, the Z8F1680 Series adds even more design flexibility and choice for many low voltage and low power applications.

### Application Notes & Source Code Files

- A Simple Console Application for Z8 Encore! XP MCUs (AN0342, AN0342-SC01)
- Develop a Dallas 1 Wire Master Using the Z8F1680 Series of MCUs (AN0331, AN0331-SC01)
- An Interrupt-Driven UART for Z8 Encore! XP and Z8 Encore! MC MCUs (AN0330, AN0330-SC01)
- Boot Loader for the Z8F082A and Z8F1680 MCUs (AN0328, AN0328-SC01)
- Enabling Low Power Modes with the Z8 Encore! XP F1680 Series MCU (AN0313, AN0313-SC01)
- Getting Started with ESPI Interface Using the Z8 Encore! XP F1680 (AN0273, AN0273-SC01)
- Z8 Encore! XP F1680 Micro Stepping Controller (AN0272, AN0272-SC01)

## Documentation

Development Kits: 28-pin, 44-pin Product Brief (PB0164)  
Product Specification (PS0250) User Manuals: UM0203, UM0212

## Z8 Encore! XP F1680 Series MCU Block Diagram

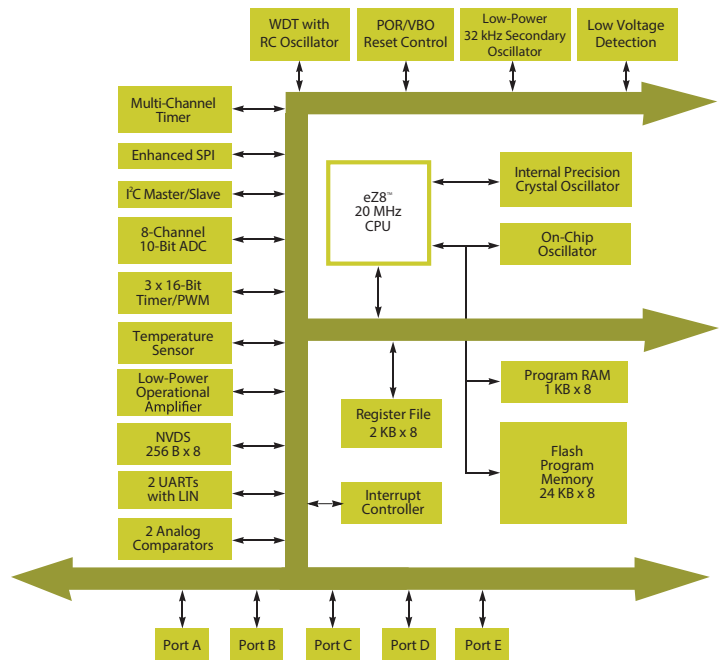

## Z8 Encore! XP F1680 Series Features and Benefits

- High-Performance 20 MHz eZ8® CPU Core
- 1.8V to 3.6V operating voltage range (standard and extended temperature ranges)
- 8KB to 24KB Flash memory
- 2KB to 3KB register RAM including 1KB assignable as low-power Program RAM
- Up to 256 bytes Non-Volatile Data Storage (NVDS)
- On-chip temperature sensor
- Low-power Op Amp and two analog comparators
- 7/8-channel 10-bit Analog-to-Digital Converter (ADC) with fast 4.9  $\mu$ s conversion time
- Three independent 16-bit multi-mode timers supporting 13 modes including PWM and Demodulation
- 4-Channel 16-bit Capture/Compare/PWM Timer Block
- Up to 37 general-purpose I/Os depending on package
- Watch Dog Timer (WDT), Power-On Reset (POR), Voltage Brown-Out (VBO)
- On-chip programmable Low Voltage Detection (LVD)
- Full-duplex ESPI, I2C, and 2 LIN UART ports
- Peripheral Power Management for analog blocks
- Built-in internal precision oscillator (IPO) with programmable output from 43.2kHz to 11MHz
- Support for external 32-KHz Oscillator
- Single-pin, on-chip debugger (OCD)
- Available in 20- and 28-pin SOIC, 20- and 28-pin SSOP, 40-pin PDIP, 44-pin LQFP, and 44-pin QFN packages



# Zilog's Z8 Encore! XP F6482 Series of Flash Microcontrollers

Based on Zilog's advanced 8-bit eZ8 CPU core, these MCUs support 1.8 V to 3.6 V low-voltage operation with extremely low Active, Halt, and Stop Mode currents

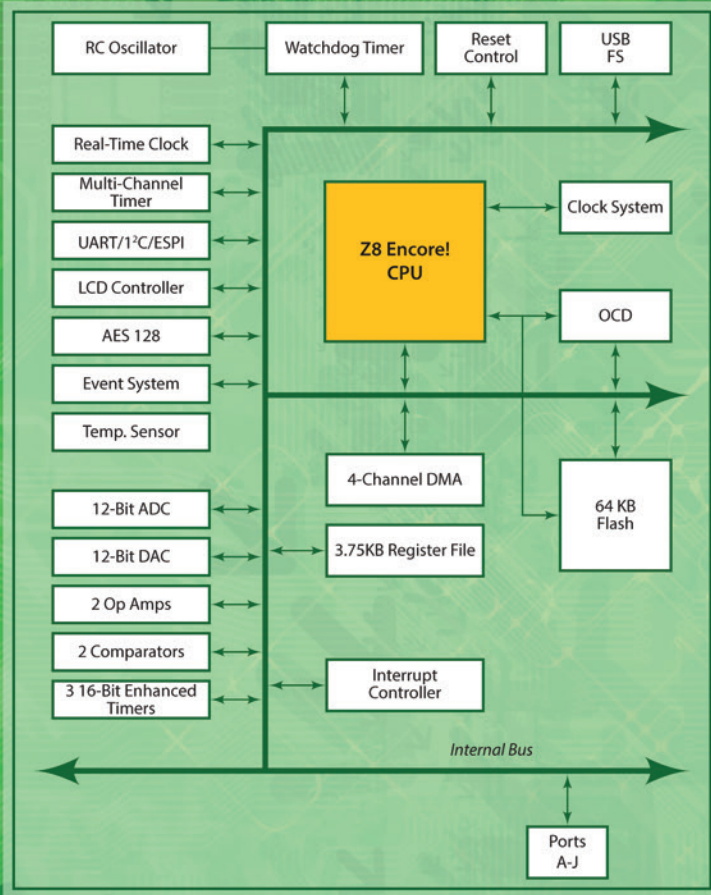

Z8F6482 Series Block Diagram

**FEATURES:**

- 24MHz eZ8 CPU core
- 16KB, 32KB, 60KB or 64KB Flash memory
- 2KB or 3.75KB internal RAM
- Two Enhanced Serial Peripheral Interface (SPI) controllers
- I<sup>2</sup>C controller which supports Master/Slave modes
- Watchdog Timer (WDT)
- 32-, 44-, 64-, and 80-pin packages
- -40°C to +85°C (extended) operating temperature range

**APPLICATIONS:**

- Battery Powered Sensors
- Wired/Wireless Keypads
- PIR Motion Detection
- Lighting Control
- Safety and Security
- Utility Metering
- Digital Power Supervisory
- Hand Held Electronics
- Wireless Controller
- LCD Keypads



Utility Metering



Wired/Wireless Keypads



Battery Powered Sensors

Part	Flash	Register RAM	128B NVDS	LCD	USB	I <sup>2</sup> C	ESPI	UART	I/O	ADC	Package	Part Number
Z8F6482	64 KB	3.75 KB	0	1	1	1	2	2	67	12	80-Pin LQFP	Z8F6482AT024XK
		3.75 KB	0	1	0	1	2	1	51	8	64-Pin LQFP	Z8F6482AR024XK
Z8F6481	64 KB	3.75 KB	0	0	1	1	2	2	52	12	64-Pin LQFP	Z8F6481AR024XK
		3.75 KB	0	0	1	1	1	2	36	10	44-Pin LQFP	Z8F6481AN024XK
		3.75 KB	0	0	1	1	1	1	26	9	32-Pin QFN	Z8F6481QK024XK

Visit the Zilog website for additional parts included in this Series.



Z8F64820100ZCOG

The **F6482 Series Development Kit** is a complete development solution containing the following tools:

- F6482 Series Development Board
- USB SmartCable (for connecting the PC to the F6482 Series Development Board)
- USB A to Mini B cable
- RS-232 interface module



Design With Freedom

For more information about the F6482 Series, or to download product collateral and software, please visit [www.zilog.com](http://www.zilog.com).



zilog®

*Embedded in Life*

An  IXYS Company

Zilog Worldwide U.S. Headquarters  
1590 Buckeye Drive | Milpitas, CA 95035-7418  
Phone: (408) 457-9000 | Fax: (408) 416-0223

[www.zilog.com](http://www.zilog.com)  
[www.ixys.com](http://www.ixys.com)

\*Zilog, Inc., 2017. All rights reserved.



Design With Freedom